

VEO-XTI2L/VEO-XRI2L

VIDEO OVER IP DISTRIBUTION

Low latency 4K over IP video extenders with KVM and video wall functionality



USER MANUAL

CONTENTS

HARDWARE.....6-55

1	IMPORTANT REMARK	6
2	IMPORTANT SAFETY INSTRUCTIONS	6
3	NOTA IMPORTANTE	8
4	INTRODUCTION	8
5	PACKAGE CONTENTS	9
	5.1 VEO-XTI2L Package.....	9
	5.2 VEO-XRI2L Package.....	9
6	PANEL DESCRIPTIONS	10
	6.1 Transmitter.....	10
	6.1.1 Front panel.....	10
	6.1.2 Rear panel.....	11
	6.2 Receiver.....	12
	6.2.1 Front panel.....	12
	6.2.2 Rear panel.....	13
	6.3 IR sensor and emitter connections.....	13
	6.4 Group ID selection using remote control.....	14
	6.5 Description of the function buttons.....	15
	6.6 Description of the audio control button	15
7	INSTALLATION AND CONFIGURATION	16
	7.1 Start-up	16
	7.2 How to find out the IP address of devices	17
	Requirements and recommendations for using a VEO IP video network	19
8	SYSTEM TOPOLOGY AND CONFIGURATIONS	20
	8.1 Point-to-point connection.....	20
	8.2 Point-to-multipoint connections and operations	20
	8.3 Multipoint-to-multipoint connections and operations	21

8.4	<i>Connections for interactive applications</i>	21
8.5	<i>Video wall mode</i>	22
9	CONFIGURATION USING ECLERNET MANAGER	23
9.1	<i>How to find devices in EclerNet Manager</i>	23
9.2	<i>How to add VEO-XTI2L and VEO-XRI2L to an EclerNet Manager project</i>	25
9.3	<i>Which functions are available when operating the devices via EclerNet Manager?</i>	28
9.3.1	<i>VEO-XTI2L Transmitter Associated Functions</i>	28
9.3.2	<i>VEO-XRI2L Transmitter Associated Functions</i>	29
9.3.3	<i>How to add control functions to a UCP (User Control Panel)</i>	30
10	CONFIGURATION USING VEO XTI2L - XRI2L CONTROL CENTRE	31
10.1	<i>How to find devices using Control Centre</i>	31
10.2	<i>Configuring the Casting mode using the Control Centre</i>	32
10.3	<i>Configuring video wall mode using the Control Centre</i>	33
11	CONFIGURATION USING THE WEB INTERFACE	35
11.1	<i>Configuring the system settings</i>	35
11.1.1	<i>Firmware information and updating</i>	35
11.1.2	<i>Utilities</i>	35
11.1.3	<i>Statistics</i>	36
11.2	<i>Configuring video wall mode using the web interface</i>	37
11.2.1	<i>Basic configuration procedure</i>	37
11.2.2	<i>Bevel and gap compensation:</i>	38
11.2.3	<i>Size of the structure and position layout</i>	39
11.2.4	<i>Preferences</i>	40
11.2.5	<i>Apply to</i>	41
11.2.6	<i>Advanced configuration</i>	42
11.3	<i>Configuring network settings</i>	46
11.3.1	<i>Auto IP</i>	46
11.3.2	<i>DHCP (Dynamic Host Configuration Protocol)</i>	47
11.3.3	<i>Configuring a static IP address</i>	48
11.3.4	<i>Casting Mode</i>	48
11.4	<i>Configuring operating functions</i>	49

11.4.1	Setting the video output mode for the receiver	50
11.4.2	Setting the scalar output mode for the transmitter	52
11.4.3	USB over IP data extension	52
12	FIBRE OPTIC CONNECTION.....	54
13	FACTORY RESET	54
14	TECHNICAL SPECIFICATIONS	55
SOFTWARE.....		56-84
* CONTROL TCP/IP.....		56-66
15	THIRD PARTY CONTROL PROTOCOL: CONNECTION AND LOGIN	57
16	CONTROL COMMANDS	58
16.1	<i>SET Channel:.....</i>	58
16.2	<i>SET Channel for a specific service:</i>	58
16.3	<i>GET channel for a specific service.....</i>	59
16.4	<i>SET Stop_link command:.....</i>	59
16.5	<i>SET reconnect command</i>	60
16.6	<i>SET HDMI Output ON command</i>	60
16.7	<i>SET HDMI Output OFF command.....</i>	60
16.8	<i>SET Video stream Pause ON.....</i>	60
16.9	<i>SET Video stream Pause OFF</i>	60
16.10	<i>Reboot command</i>	61
17	VIDEO WALL COMMANDS.....	61
18	HOW TO USE VEO-XTI2L and VEO-XRI2L as a TCP/RS232 converter.....	63
19	HOW TO SEND CONTROL COMMANDS USING ECLERNET MANAGER	64
19.1	<i>Ecler Net Manager Net String Syntax.....</i>	64
19.2	<i>Ecler Net Manager Net String Examples</i>	65
* How to configure a Cisco SG300 Ethernet Switch.....		67-77
20	HOW TO CONFIGURE A CISCO SG300 ETHERNET SWITCH INTRODUCTION	68
21	ESTABLISHING COMMUNICATION WITH THE CISCO ETHERNET SWITCH.....	68
22	ENABLING IGMP PROTOCOL.....	69

23	ENABLING JUMBO FRAME.....	73
24	CONFIGURING THE DHCP SERVER	74
* How to configure D-Link DGS-1210 Ethernet Switch.....		78-84
25	HOW TO CONFIGURE D-LINK DGS-1210 ETHERNET SWITCH INTRODUCTION	79
26	ESTABLISHING COMMUNICATION WITH D-LINK ETHERNET SWITCH	79
27	ENABLING IGMP PROTOCOL.....	79
28	ENABLING Jumbo Frame.....	80
29	Disabling POWER Saving and EEE (Energy Efficient Ethernet)	81
30	CREATING VLANS FOR DANTE™, VIDEO OVER IP AND CONTROL COEXISTENCE.....	82

1 IMPORTANT REMARK



WARNING: SHOCK HAZARD - DO NOT OPEN
AVIS: RISQUE DE CHOC ÉLECTRIQUE - NE PAS OUVRIR



The lightning flash with arrowhead symbol, within an equilateral triangle, is intended to alert the user to the presence of uninsulated “dangerous voltage” within the product’s enclosure that may be of sufficient magnitude to constitute a risk of electric shock to persons.



The exclamation point within an equilateral triangle is intended to alert the user to the presence of important operating and maintenance (servicing) instructions in the literature accompanying the appliance.

WARNING (If applicable): The terminals marked with symbol of “” may be of sufficient magnitude to constitute a risk of electric shock. The external wiring connected to the terminals requires installation by an instructed person or the use of ready-made leads or cords.

WARNING: To prevent fire or shock hazard, do not expose this equipment to rain or moisture.

WARNING: An apparatus with Class I construction shall be connected to a mains socket-outlet with a protective earthing connection.

2 IMPORTANT SAFETY INSTRUCTIONS

1. Read these instructions.
2. Keep these instructions.
3. Heed all warnings.
4. Follow all instructions.
5. Do not use this apparatus near water.
6. Clean only with dry cloth.
7. Do not block any ventilation openings. Install in accordance with the manufacturer’s instructions.

8. Do not install near any heat sources such as radiators, heat registers, stoves, or other apparatus (including amplifiers) that produce heat.
9. Do not defeat the safety purpose of the polarized or grounding type plug. A polarized plug has two blades with one wider than the other. A grounding type plug has two blades and a third grounding prong. The wide blade or the third prong are provided for your safety. If the provided plug does not fit into your outlet, consult an electrician for replacement of the obsolete outlet.
10. Protect the power cord from being walked on or pinched particularly at the plugs, convenience receptacles, and at the point where they exit from the apparatus.
11. Only use attachments/accessories specified by the manufacturer.
12. Unplug the apparatus during lightning sorts or when unused for long periods of time.
13. Refer all servicing to qualified personnel. Servicing is required when the apparatus has been damaged in any way, such as power supply cord or plug is damaged, liquid has been spilled or objects have fallen into the apparatus, the apparatus has been exposed to rain or moisture, does not operate normally, or has been dropped.
14. Disconnecting from mains: When switching off the POWER switch, all the functions and light indicators of the unit will be stopped, but fully disconnecting the device from mains is done by unplugging the power cable from the mains input socket. For this reason, it always shall remain easily accessible.
15. Equipment is connected to a socket-outlet with earthing connection by means of a power cord.
16. The marking information is located at the bottom of apparatus.
17. The apparatus shall not be exposed to dripping or splashing and that no objects filled with liquids, such as vases, shall be placed on apparatus.

NOTE: *This equipment has been tested and found to comply with the limits for a Class A digital device, pursuant to part 15 of the FCC Rules. These limits are designed to provide reasonable protection against harmful interference when the equipment is operated in a commercial environment. This equipment generates, uses, and can radiate radio frequency energy and, if not installed and used in accordance with the instruction manual, may cause harmful interference to radio communications. Operation of this equipment in a residential area is likely to cause harmful interference in which case the user will be required to correct the interference at his own expense.*



WARNING: This product must not be discarded, under any circumstance, as unsorted urban waste. Take to the nearest electrical and electronic waste treatment centre.

NEEC AUDIO BARCELONA, S.L. accepts no liability for any damage that may be caused to people, animal or objects due to failure to comply with the warnings above.

3 NOTA IMPORTANTE

Thank you for choosing our **VEO-XTI2L & VEO-XRI2L Low Latency 4K Video Over IP Extenders!**

It is **VERY IMPORTANT** to carefully read this manual and to fully understand its contents before any connection in order to maximize your use and get the best performance from this equipment.

To ensure optimal operation of this device, we strongly recommend that its maintenance be carried out by our authorised Technical Services.

Ecler **VEO-XTI2L & VEO-XRI2L** comes with a **3-year warranty**.

4 INTRODUCTION

The VEO-XTI2L and VEO-XRI2L represent a highly versatile solution for distributing video, audio and control signals over a local area network (LAN). They can be used as 4K over IP video, audio and KVM extenders, in multiple configurations, such as point-to-point, point-to-multipoint and multipoint-to-multipoint, or as a device for putting together video wall structures. They also include USB, RS232 and IR signal pass-through control functions, and can be easily configured and managed using EclerNet Manager, which is a piece of utility software for PC (as they are compatible devices), or through the web interface.

Features:

- 4K UHD HDMI over IP/Fibre Extension
- USB2.0 over IP extension
- Support for transmission distances of up to 120m, over a single Cat 5e/6 cable
- Support for fibre optic extensions of up to 60Km (Single-mode)
- Supports up to 3840x2160@60Hz input YUV 4:2:0 and 3840x2160@30Hz output.
- HDCP 2.2 / HDCP1.4 compliant
- Support for bi-directional wide band IR (38KHZ-56KHZ) pass-through
- Support for RS232 pass-through and Telnet control
- Includes remote control for infrared/front panel for the group identification channel, with LED display to show group identification in use

- Support for Dolby True HD and DTS-HD Master audio formats
- Support for 3D video formats
- Embedded and unembedded 5.1 SPDIF and analogue stereo L/R
- Support for putting together video wall structures (Maximum size is 8x8)
- Easy installation over gigabit- and IGMP-compliant LANs
- Support for PoE (Power over Ethernet) or 5V-18V external power.

5 PACKAGE CONTENTS

5.1 VEO-XTI2L Package

- 1 x 4K over IP transmitter
- 1 x IR remote control
- 1 x IR TX cable
- 2 x IR RX cable
- 1 x Phoenix connector (Euroblock) for the end of the RS232 cable
- 4 x screws
- 2 x detachable mounting tabs
- 1 x 5VDC power adaptor with international pins

5.2 VEO-XRI2L Package

- 1 x 4K over IP receiver
- 1 x IR remote control
- 1 x IR TX cable
- 2 x IR RX cable
- 1 x Phoenix connector (Euroblock) for the end of the RS232 cable
- 4 x screws
- 2 x detachable mounting tabs
- 1 x 5VDC power adaptor with international pins

6 PANEL DESCRIPTIONS

6.1 Transmitter

6.1.1 Front panel

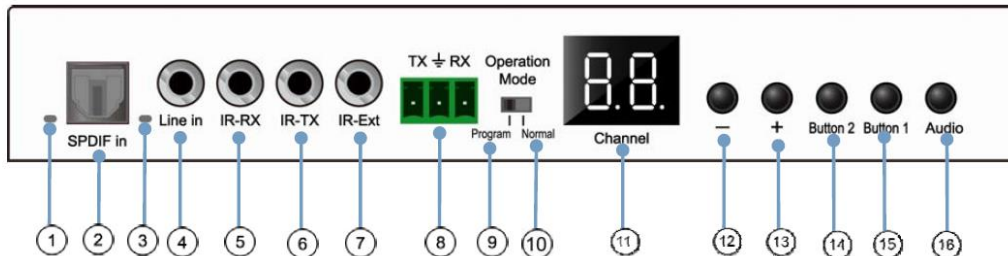

1. Not enabled
2. Not enabled
3. Analogue audio status indicator
4. Line input connector for analogue audio
5. IR-RX connector for IR sensor
6. IR-TX connector for IR emitter
7. IR sensor for remote control
8. RS232 Full-Duplex Port
9. Program mode: In this mode, the RS232 port is used to control the unit, deactivating the IR-EXT port
10. Normal Mode: In this mode, the RS232 port will act as a pass-through extension
11. Group ID LED screen
12. Group ID DECREASE button
13. Group ID INCREASE button
14. Function button (see the [Description of the function buttons](#) chapter)
15. Function button (see the [Description of the function buttons](#) chapter)
16. HDMI, S/PDIF or Analogue Audio selection button (the default audio selection is HDMI)

6.1.2 Rear panel

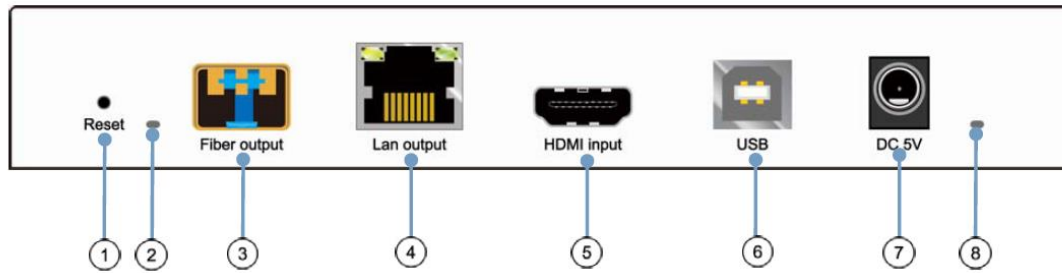

1. Reset button (push for 1 second to reset the device)
2. Fibre optic connection indicator
3. Fibre optic SFP receptacle
4. Cat. 5e/6 connector
5. HDMI input port
6. USB input (Type B)
7. DC 5V input connector
8. LED power indicator

6.2 Receiver

6.2.1 Front panel

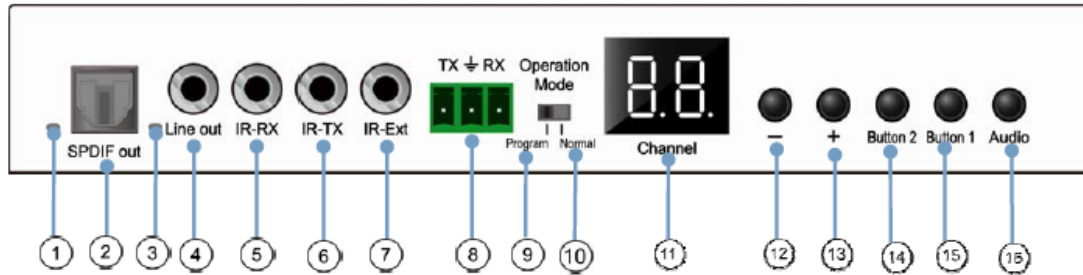

1. S/PDIF status indicator
2. Audio Output S/PDIF Connector
3. Analogue audio status indicator
4. Analogue audio line out connector
5. IR-RX connector for IR sensor
6. IR-TX connector for IR emitter
7. IR sensor for remote control
8. RS232 Full-Duplex Port
9. Program Mode: In this mode, the RS232 port is used to control the unit, deactivating the IR-EXT port
10. Normal Mode: In this mode, the RS232 port will act as a pass-through extension
11. Group ID LED screen
12. Group ID DECREASE button
13. Group ID INCREASE button
14. Function button (see the [Description of the function buttons](#) chapter)
15. Function button (see the [Description of the function buttons](#) chapter)
16. HDMI, S/PDIF or Analogue Audio selection button (the default audio selection is HDMI)

6.2.2 Rear panel

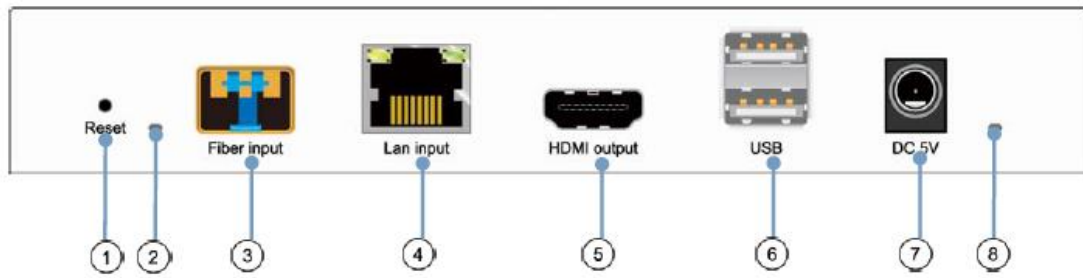

1. Reset button (push for 1 second to reset the device)
2. Fibre optic connection indicator
3. Fibre optic SFP receptacle
4. Cat. 5e/6 connector
5. HDMI output port
6. USB input (Type A)
7. DC 5V input connector
8. LED power indicator

6.3 IR sensor and emitter connections



6.4 Group ID selection using remote control

The Group ID, or group identifier can be selected using the IR remote controller included. You must ensure that the IR-Ext sensor is connected (see '[Package contents](#)' chapter). The remote control can be used to change the group ID, as explained below.



- Once the two-digit group number is displayed, press "+" or "-" to select the previous group ID, or the next one
- Press the numbers to select the desired group ID. For example, if you need to change to 01, press "0", and then press "1"

Example:



TX 1



RX 1

6.5 Description of the function buttons

Transmitter		Receiver	
Button One	Button Two	Button One	Button Two
Link ON/OFF	Video/Graphic Mode	Link ON/OFF	Video/Graphic Mode

Characteristic	Description
Link	By pressing this button, you can activate or deactivate the video streaming. When the video signal is deactivated, the standby screen will reappear on the target monitor, indicating the current status, until transmission is no longer enabled.
Video/Graphic Mode	<p>The user can select video mode or graphic mode by pressing this button:</p> <ul style="list-style-type: none"> • Video mode: Video stability will be prioritized over bandwidth and resolution, in order to ensure a smooth playback experience • Graphic mode: The best viewing experience will be ensured, for graphic/text dominated streams <p>When you press the button to switch between the modes, text will appear in the centre of the target monitor, in green, indicating which mode is active ("Graphic Mode" or "Video Mode")</p>

Note: The status of the buttons will be stored in the internal flash memory, and will be remembered after it is rebooted

6.6 Description of the audio control button

Transmitter

The "Audio" button on the VEO-XTI2L transmitter allows the "Line in" input to be selected. The external audio will be embedded in the video stream of the HDMI input, overwriting any original audio that may exist

Receiver

The "Audio" button on the VEO-XRI2L receiver selects between the "Line out" and "SPDIF out" outputs, through which a copy of the audio received from the transmitter will be extracted. The audio from the HDMI video signal will still be present in the video stream in either case

7 INSTALLATION AND CONFIGURATION

7.1 Start-up

1. Check that the power supply is unplugged
2. Connect the transmitter to the video source, and the receiver to a monitor or display, using HDMI cables
3. Connect the USB cables from the transmitter to the PC, and connect additional USB devices such as the USB mouse, USB keyboard and USB memory stick to the receiver
4. Connect the transmitter and receiver to the Ethernet switch using the network cable
5. Switch on and activate all connected devices
6. Switch on the transmitter, receiver or PoE switch
7. Connect the IR extension cable to the transmitter, and the IR receiver cable to the receiver, in order to have remote control

7.2 How to find out the IP address of devices

VEO-XTI2L and VEO-XRI2L devices have the "Auto IP" function set by default. This provides automatic IP address assignment on devices that are connected to the same network. The factory-set IP subnet is 169.254.x.y.

To find out the IP for each device, it is recommended to consult the '[How to find devices in EclerNet Manager](#)' and '[How to find devices using Control Centre](#)' chapters.

If you do not have a PC, it is also possible to find out the IP address using the following procedure:

Receiver

- Connect the HDMI output of the receiver to a display. The receiver will display the IP address information in the lower right-hand corner of the monitor. The 'Local IP' is the address for the receiver

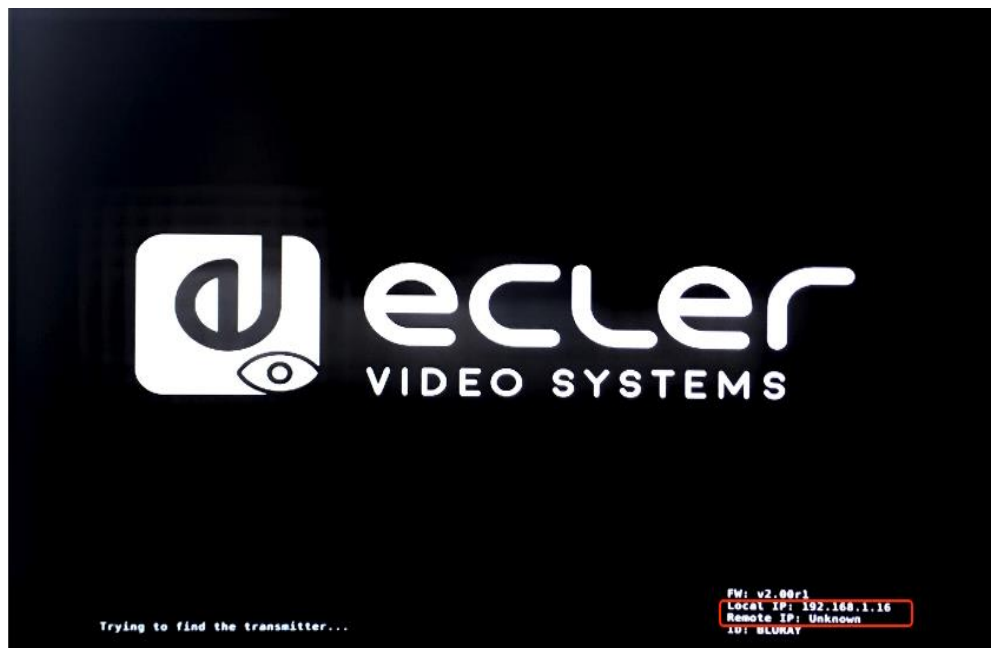

Transmitter

- Connect the transmitter, with no source connected to the HDMI input on the receiver. Then, with the RX connected to a display via the HDMI output, select the same Group ID for both devices using the front panel buttons. The IP address information for both devices will be displayed in the lower right-hand corner of the monitor. The 'Local IP' is the address of the receiver and the 'Host IP' is the address of the transmitter.



Requirements and recommendations for using a VEO IP video network

It is necessary to use gigabit switches with support for Jumbo Frame (or, if this is not available, the ability to extend the size of the IP packet) and IGMP. This will create the most appropriate scenario both for standalone IP video networks, and for cases where IP video systems share the network with other data streams.

The typical transmission speed generated by these devices is approximately 300Mbps, so the use of dedicated networks or VLANs is highly recommended. You must ensure that the processing performance of the gigabit switch is greater than the performance required by the VEO system.

The measured bandwidth shows the video traffic in a typical installation, providing both the average value and the minimum and maximum performance variations (Mbps) in the table below:

Video Resolution	Quality Level	Max Frame Rate	Average Network Bandwidth (Mbps)
3840x2160 (2160p30)	Auto	30	218 (146~268)
1920x1080 (1080p)	Auto	60	133 (80~210)
1280x720 (720p)	Auto	60	147 (112~177)
1600x1200 (UXGA)	Auto	60	81 (57~105)
1280x1024 (SXGA)	Auto	60	113 (79~150)
1024x768 (XGA)	Auto	60	81 (72~120)
800x600 (SVGA)	Auto	60	66 (49~82)
640x480 (VGA)	Auto	60	43 (29~56)

8 SYSTEM TOPOLOGY AND CONFIGURATIONS

Note: Connecting or disconnecting HDMI cables while VEO devices are switched on may result in video signal dropouts while a stable connection is re-established.

8.1 Point-to-point connection

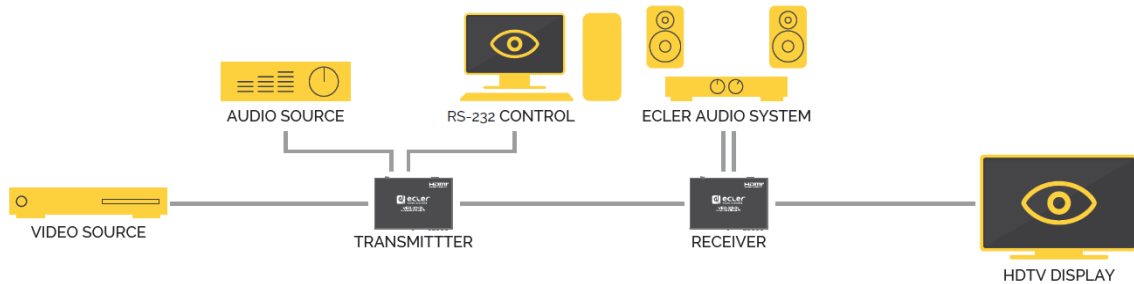

When the VEO-XTI2L and VEO-XRI2L are connected as a simple extension within a point-to-point topology, no configuration is required. The devices have a default setting of "Auto IP" (169.254.x.x), and each transmitter will send a unicast video stream to the corresponding receiver when the same Group ID is selected. Point-to-point connection is the default.

8.2 Point-to-multipoint connections and operations

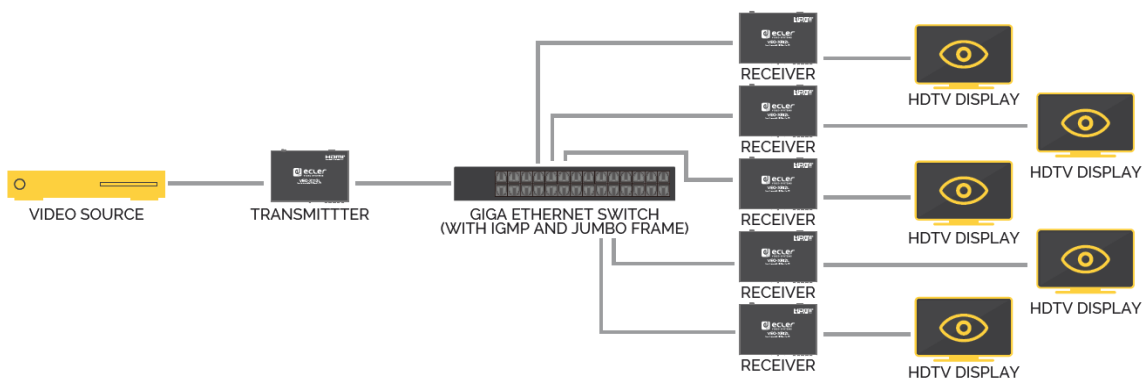

When the VEO-XTI2L and VEO-XRI2L are connected as a distribution system within a point-to-multipoint connection, both the transmitters and the receivers must be configured as multicast (refer to the '[Which functions are available when operating the devices via EclerNet Manager?](#)', '[Configuring the Casting Mode using the Control Centre](#)' and '[Casting Mode](#)' chapters in this manual). Each receiver must be set to the same group ID as the transmitter.

8.3 Multipoint-to-multipoint connections and operations

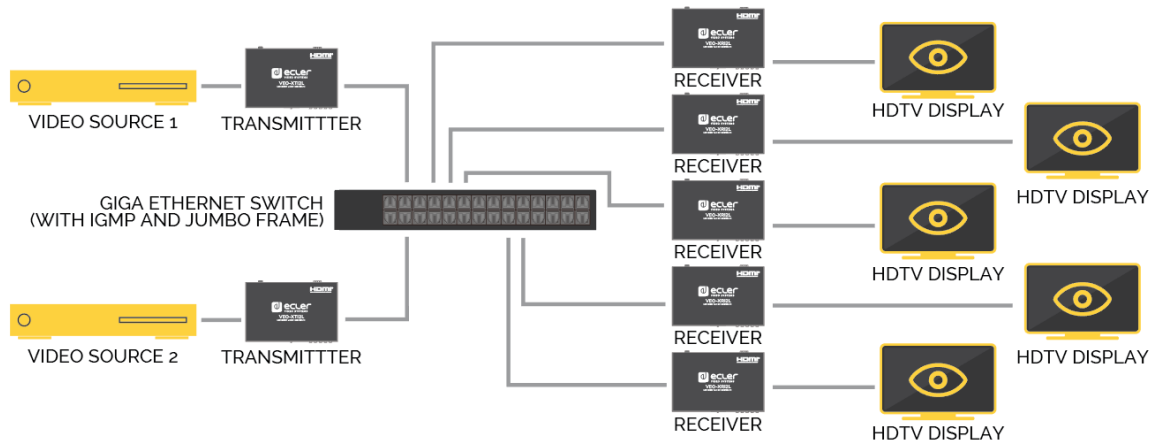

When the VEO-XTI2L and VEO-XRI2L are to be used as an IP matrix system within a multipoint-to-multipoint connection, both the transmitters and the receivers must be configured as multicast devices. Each receiver can decode the stream related to the group ID of the desired transmitter.

8.4 Connections for interactive applications

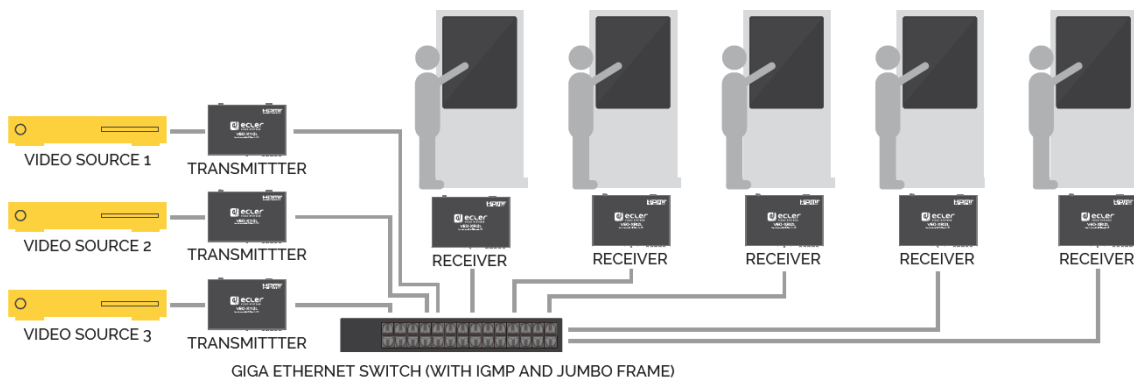

When it is necessary to control interactive video content via touch screens, or to have KVM extensions (keyboard, mouse, video), the USB signals must be extended, in addition to the video signals. Refer to the '[USB data over IP Extension](#)' chapter of this manual for further instructions.

8.5 Video wall mode

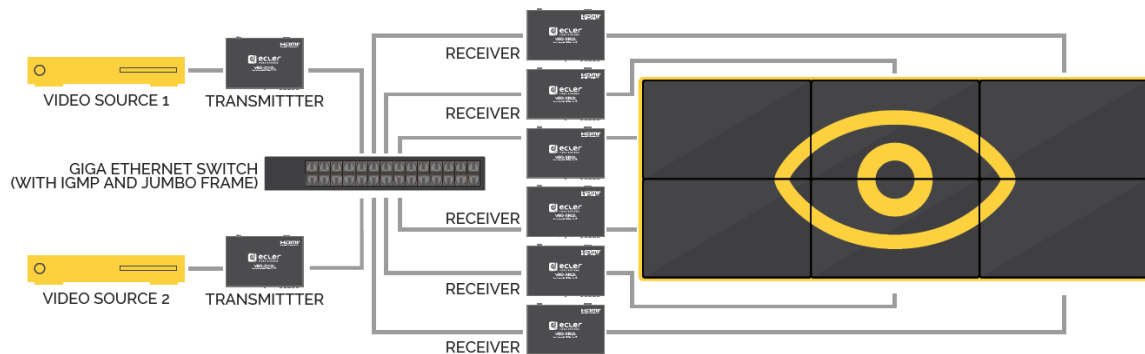

When the VEO-XTI2L and VEO-XRI2L are to be used in video wall mode, both the transmitters and the receivers must be configured as multicast devices. Each receiver must be set to the same Group ID as the transmitter, following the instructions provided in the '[Configuring video wall mode using the control centre](#)' and '[Configuring video wall mode using the web interface](#)' chapters of this manual.

In a video wall type structure, configurations should not exceed the following:

- More than 253 transmitters
- More than 64 receivers (dimensions 8x8, 64x1, etc.)

Note: In a class B network, the total number of VEO devices (transmitters and receivers) cannot exceed 65000 units.

9 CONFIGURATION USING ECLERNET MANAGER

VEO-XTI2L and VEO-XRI2L are devices that are compatible with EclerNet Manager. In order to be able to start working with them in a project, all you need is the latest versions of the management software and the firmware for these devices (from version v2.00r0). Once these are connected to your installation's network, as described in the 'Commissioning' chapter, you can start the configuration process.

9.1 How to find devices in EclerNet Manager

Start up the EclerNet Manager software and select the corresponding network card. Then, open the "Online and Unused Device List" tab. The software will automatically discover all the VEO-XTI2L and VEO-XRI2L devices present on the network and list them in the window in question.

Note: only the elements that do not belong to an existing project will appear

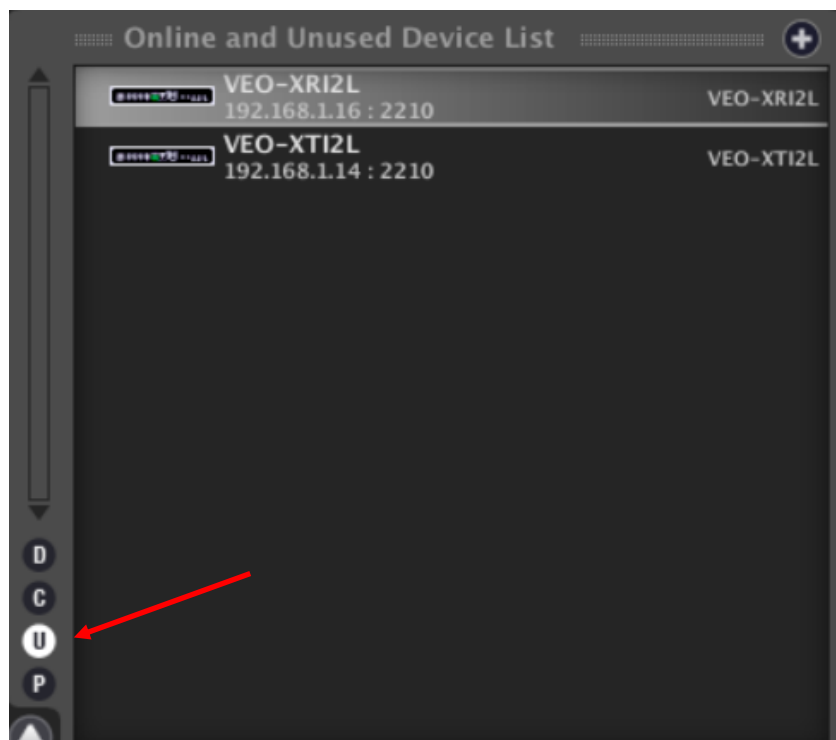

In this way, you can easily discover which IP address belongs to each piece of equipment. It is important to remember that the discovery process will show all the devices connected to the network, regardless of whether they are within the same visible range as the control computer or not. However, in order to configure and/or make use of them, it will be essential that both the selected network card and these devices are within the same network domain.

If you need to modify any of the network parameters of the discovered pieces of equipment, simply right-click on the selected element to display the action menu, and choose the "Network Configuration" option, where you can modify the information related to the network identifier.

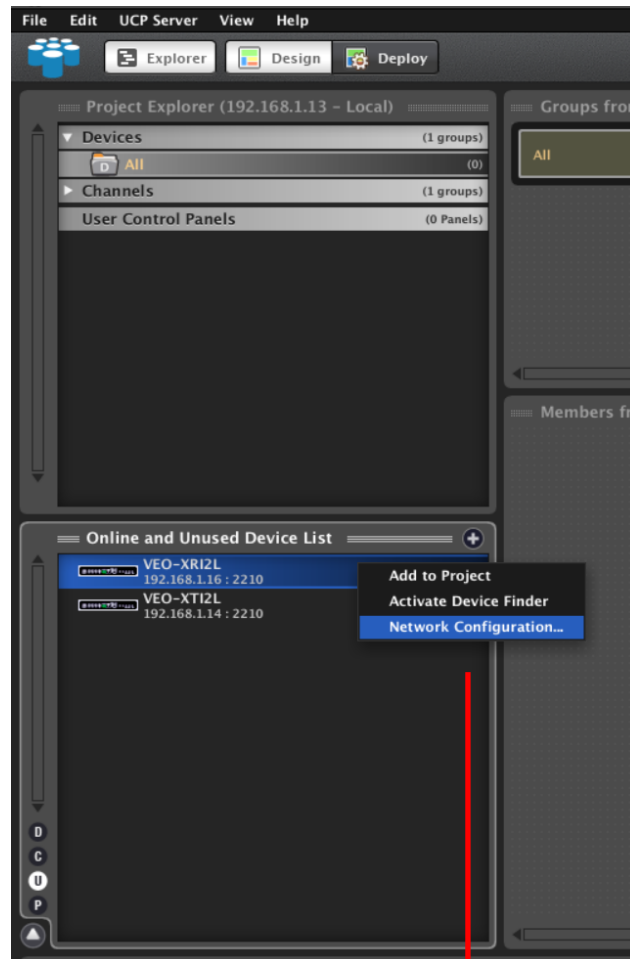

If any of the pieces of equipment does not belong to the network, the control computer must be configured within the network range of the device in question, and the process must be repeated in order to modify the equipment's IP address to the desired range.

9.2 How to add VEO-XTI2L and VEO-XRI2L to an EclerNet Manager project

Once all the devices have been discovered, they can be incorporated into an EclerNet Manager project by simply dragging each individual element into any of the work areas of the software, shown with a green box.

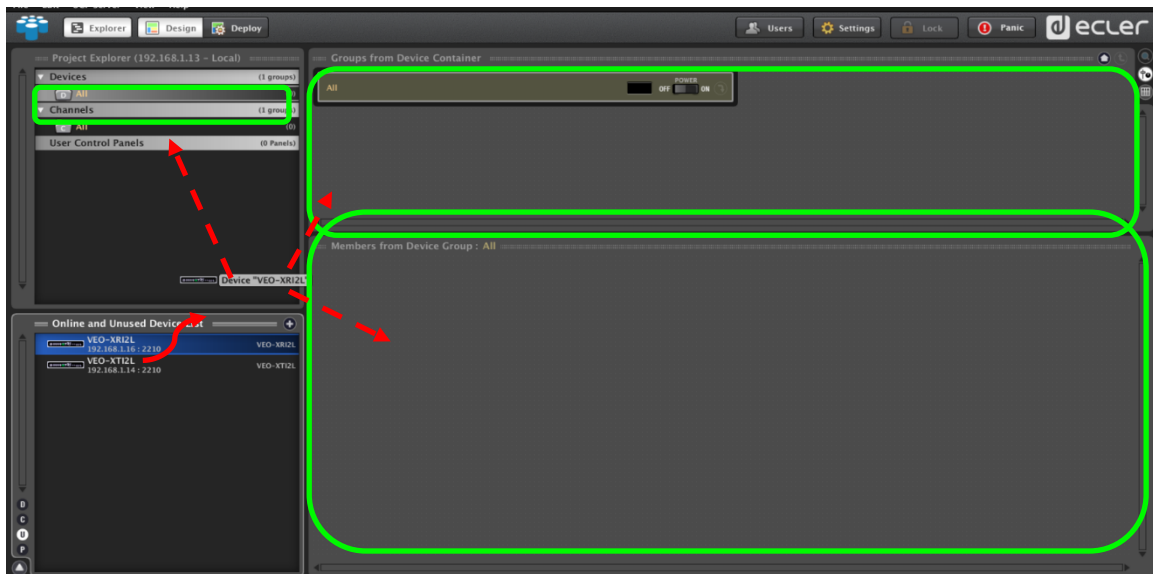

To add all the elements at once, use the "Add All to Project" function

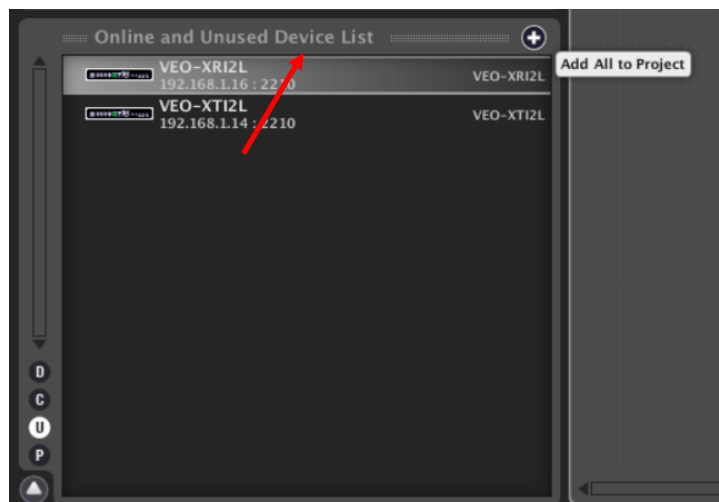

As soon as this process is completed, the added devices will appear in the "Devices" window and disappear from the "Online and Unused Device List" box. If the green indicator appears, it means that these elements are ready to be configured and/or used.

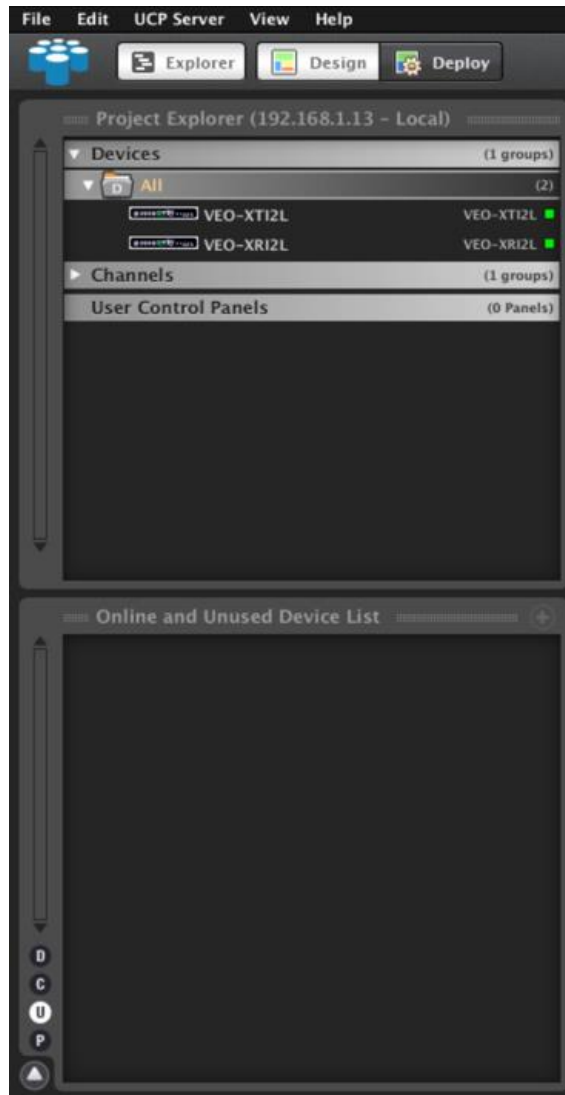

Otherwise, if the indicator is red, you need to investigate the reason for this. The most likely reason is that this equipment is not within the same network range as the control computer.

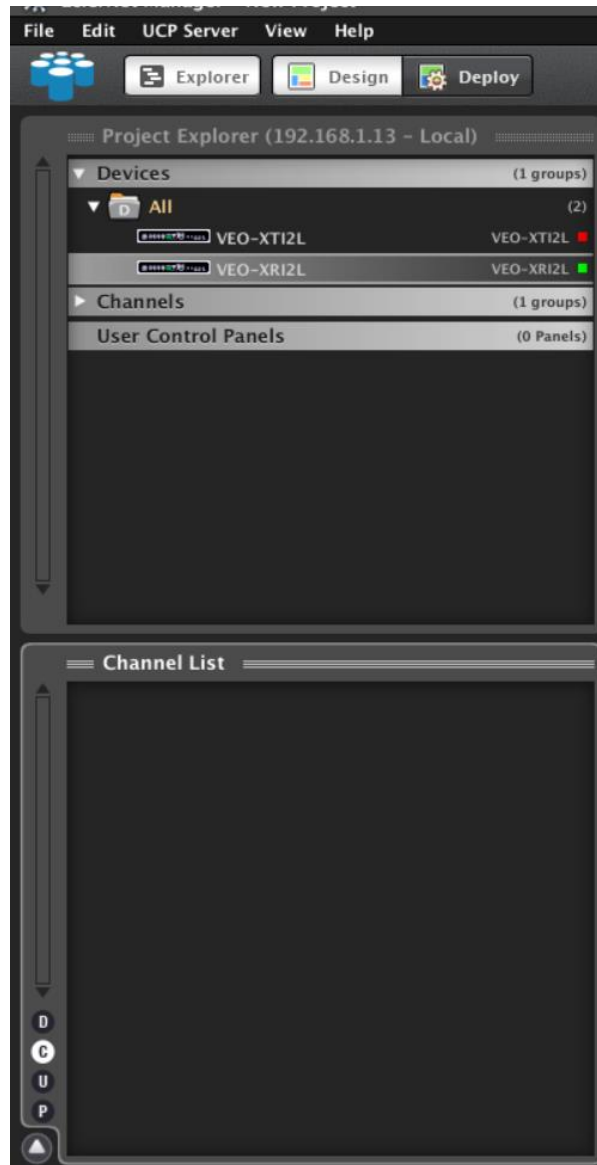

9.3 Which functions are available when operating the devices via EclerNet Manager?

The VEO-XTI2L and VEO-XRI2L devices allow different functions associated with the internal characteristics of each of the pieces of equipment to be controlled:

9.3.1 VEO-XTI2L Transmitter Associated Functions

You will be able to control the following parameters for the VEO-XTI2L transmitter:

- **CONFIG:** this section allows you to select "Unicast" or "Multicast" transmission mode
- **NETWORKING:** This section opens the dialogue box that allows you to modify the device's network information
- **SETTINGS:** This section allows you to select the transmission channel that the transmitter will work on

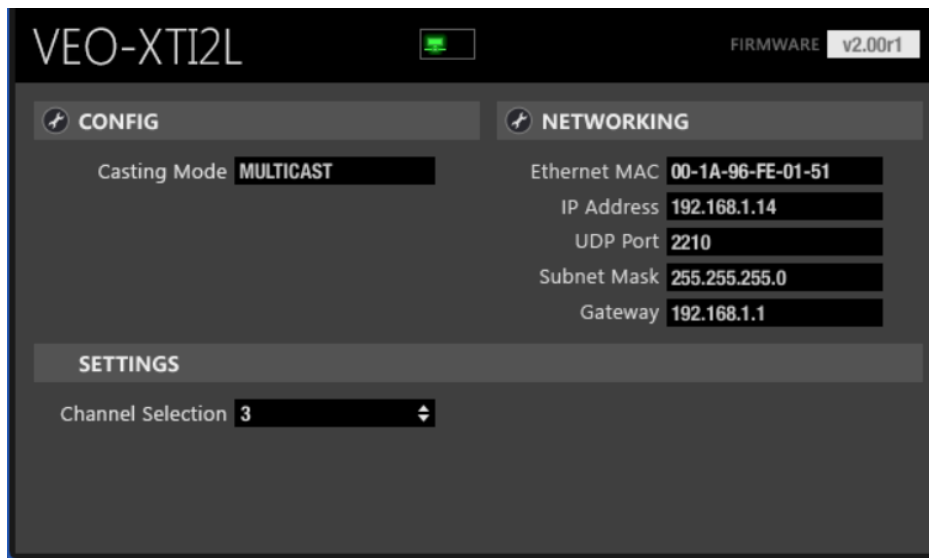

9.3.2 VEO-XRI2L Transmitter Associated Functions

You will be able to control the following parameters for the VEO-XRI2L transmitter:

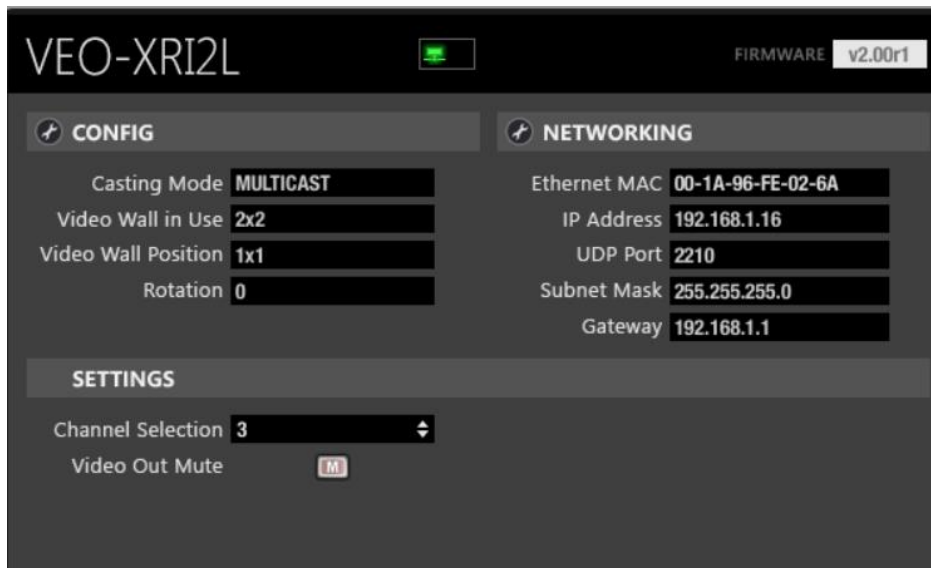

- **CONFIG:** this section allows you to select "Unicast" or "Multicast" transmission modes, on the one hand, and the "Videowall" operating mode. In addition, you can set and adjust the dimensions and layout of an image once it is activated

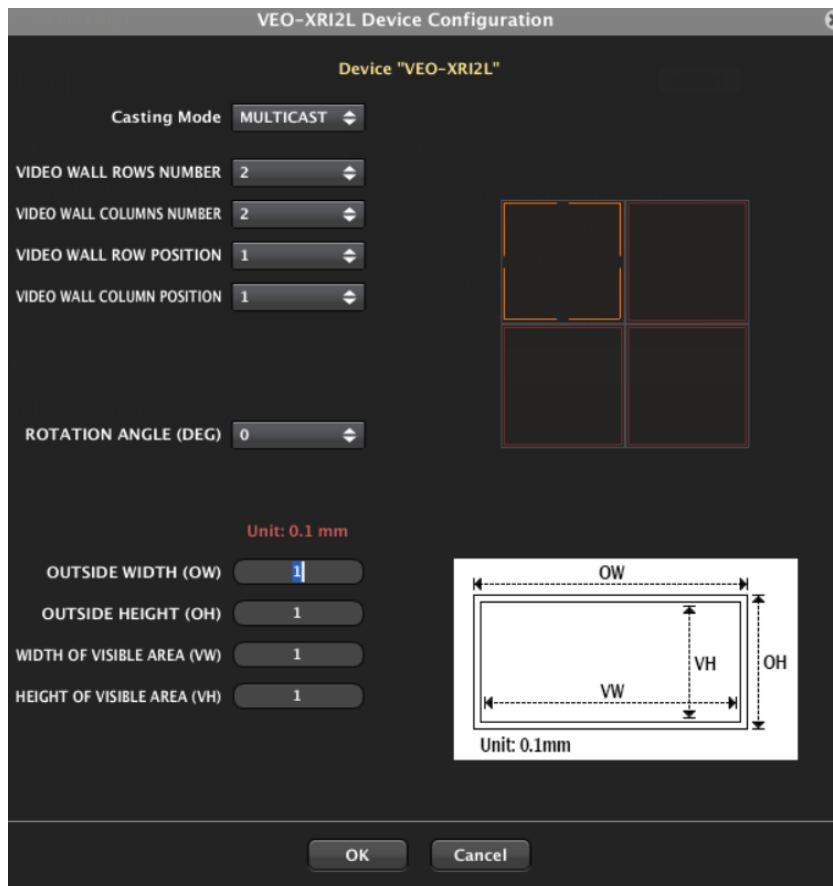

- **NETWORKING:** This section opens the dialogue box that allows you to modify the device's network information
- **SETTINGS:**
 - **Channel Selection:** This parameter allows you to select the transmission channel that the receiver will work on
 - **Video Mute Out:** This function allows you to activate/deactivate the output video signal on the receiver

9.3.3 How to add control functions to a UCP (User Control Panel)

These functionalities can be implemented in user control panels (UCP). First, you need to create or import an existing panel. Once the relevant buttons have been added, double click to display the dialogue box where each of the functions can be assigned.

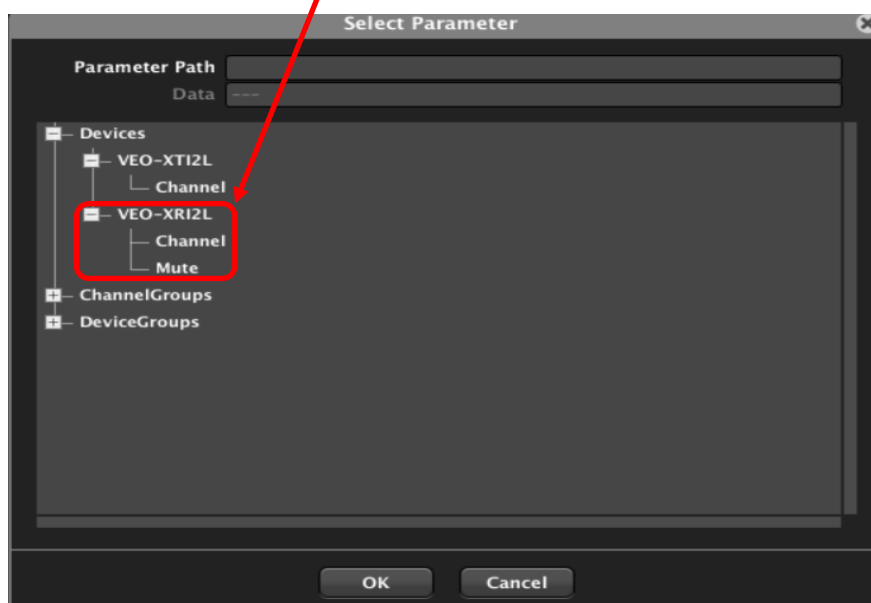
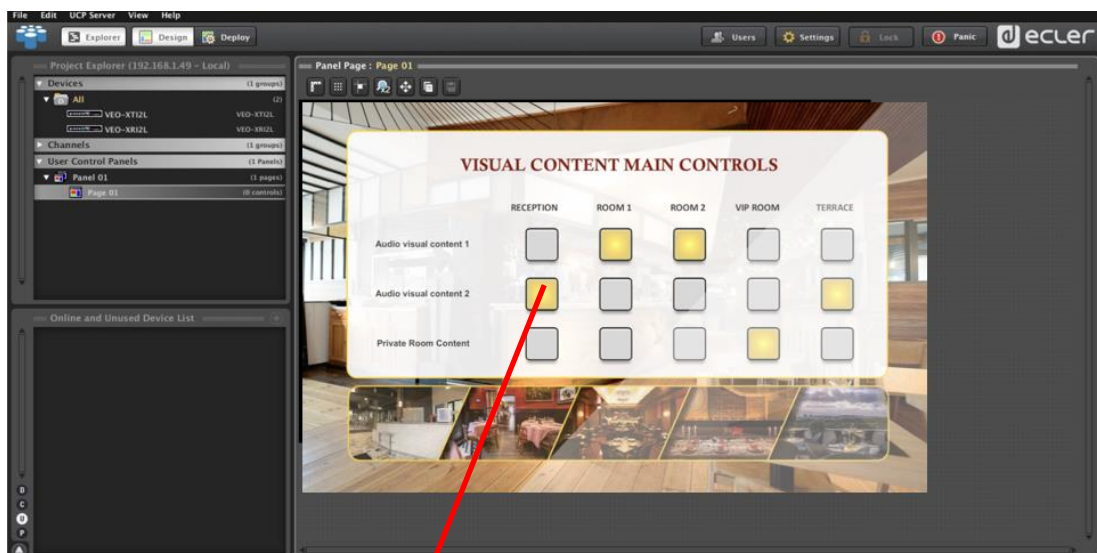

It is also possible to add Net String buttons, in order to operate these devices using control commands. This operation is described in the "[Ecler VEO-XTI2L and VEO-XRI2L TCP-IP Control Manual](#)" document associated with this user guide.

10 CONFIGURATION USING VEO XTI2L - XRI2L CONTROL CENTRE

If any of the devices has firmware that is older than version 2.00r0, it will not be compatible with EclerNet Manager. In this case, the only available way to manage the equipment will be by means of the *VEO-XTI2L - XRI2L Control Centre* utility software for PC. Once the software is installed, make sure that the PC and the VEO devices are within the same network domain. To check the IP address of the devices, refer to the '[How to find out the IP address of devices](#)' chapter.

10.1 How to find devices using Control Centre

Run the software and the device scan page will appear. Click on the "Start Scan" button to search for active devices on the network, and find out their IP address. By default, both transmitters and receivers are set to "Unicast" and "Auto IP" mode.

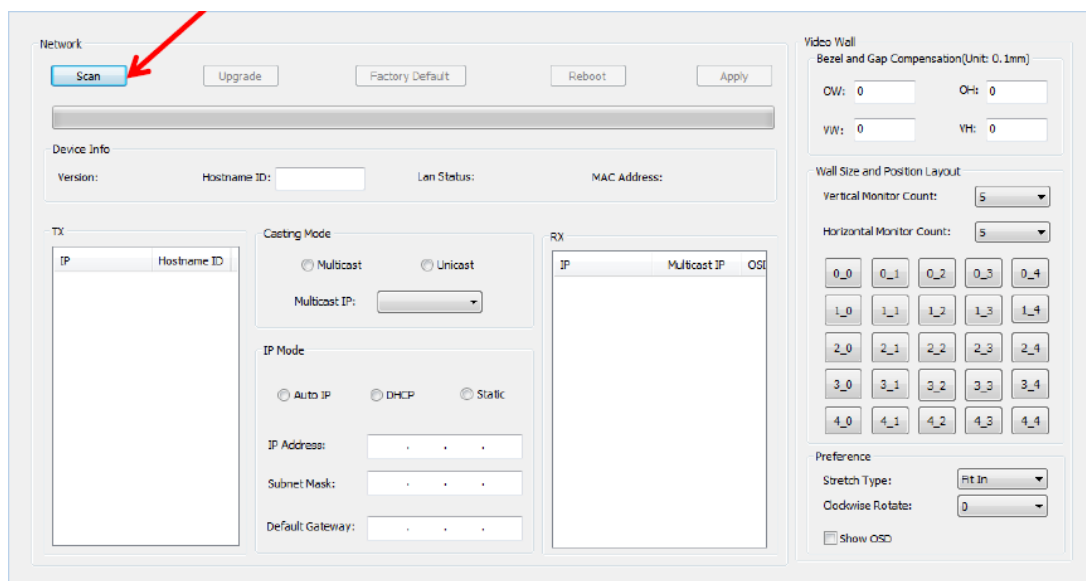

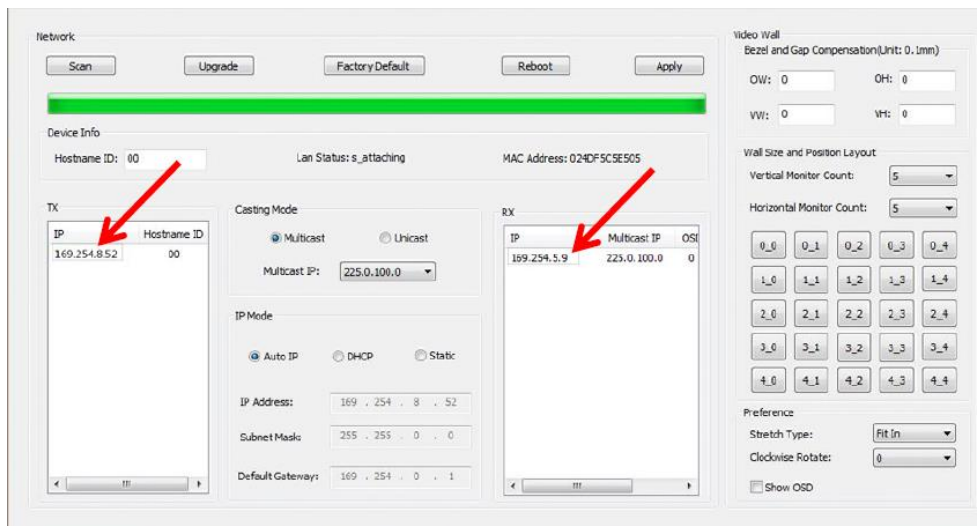

In order to change parameters, such as the IP address, host ID, casting mode or Ip mode, just select the device you want to configure and enter the required data. This page also allows you to perform a device reset or a factory reset from the remote control of the selected device.

You must click "Apply" after making changes.

10.2 Configuring the Casting mode using the Control Centre

To put together a video wall, the transmitters and receivers must be configured with the same IP multicast (group ID).

In the multipoint-to-multipoint, matrix and video wall configurations, the transmitters and receivers must be configured in multicast mode. You need to change the casting mode from unicast to multicast, as shown below, and click "Apply" to confirm the new configuration.

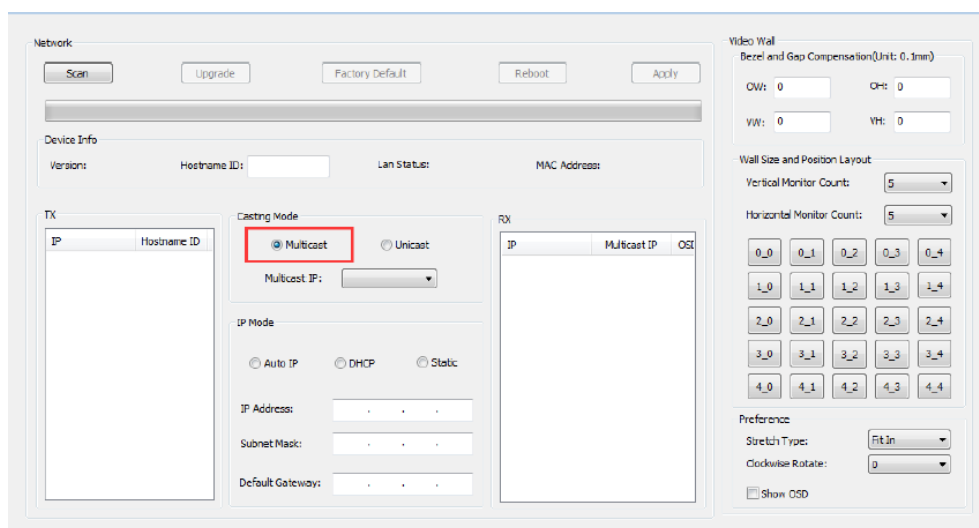

10.3 Configuring video wall mode using the Control Centre

To put together a video wall, the transmitters and receivers must be configured with the same IP multicast (group ID).

The group ID of each device can be selected using software. Each group ID corresponds to a multicast IP address, as shown below.

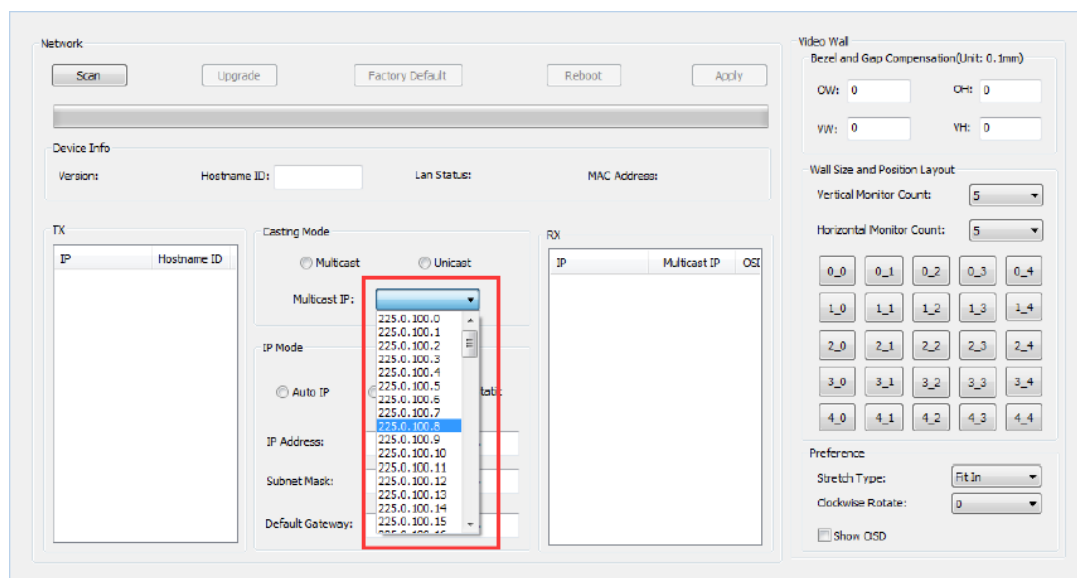

The "Vertical Monitor Count" and "Horizontal Monitor Count" should be changed according to the size of the desired video wall structure.

Example: If a 2x2 video composition is required, the first two fields, "Frame size and position layout", will be set to "2", as shown in the figure below:

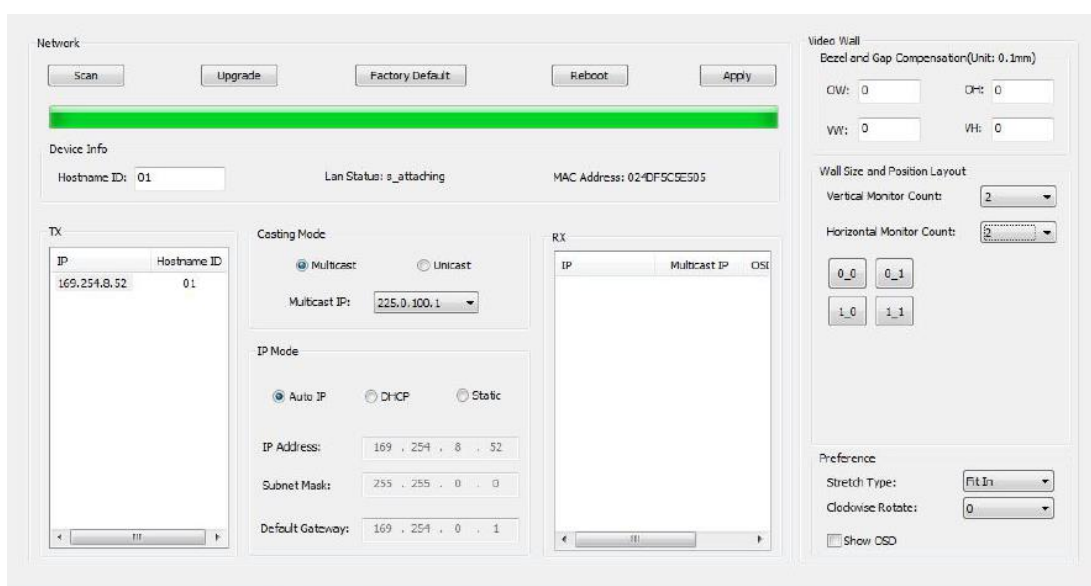

By activating the "Show OSD" function, an OSD number will be assigned and displayed on each screen. This is a useful feature for identifying each receiver and monitor.

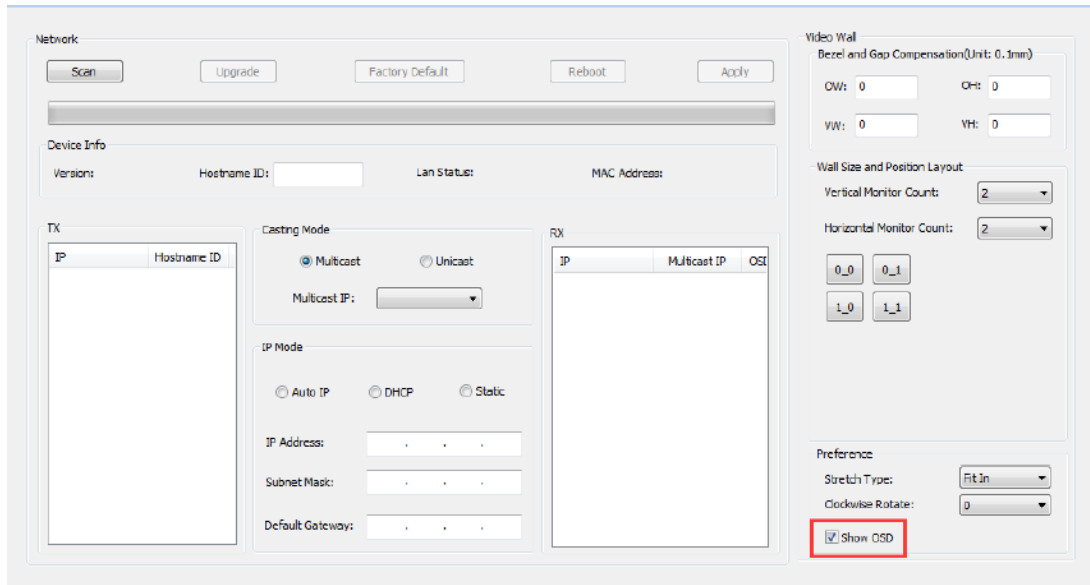

You need to drag and drop the OSD number received in the corresponding position on the video wall, as shown below:

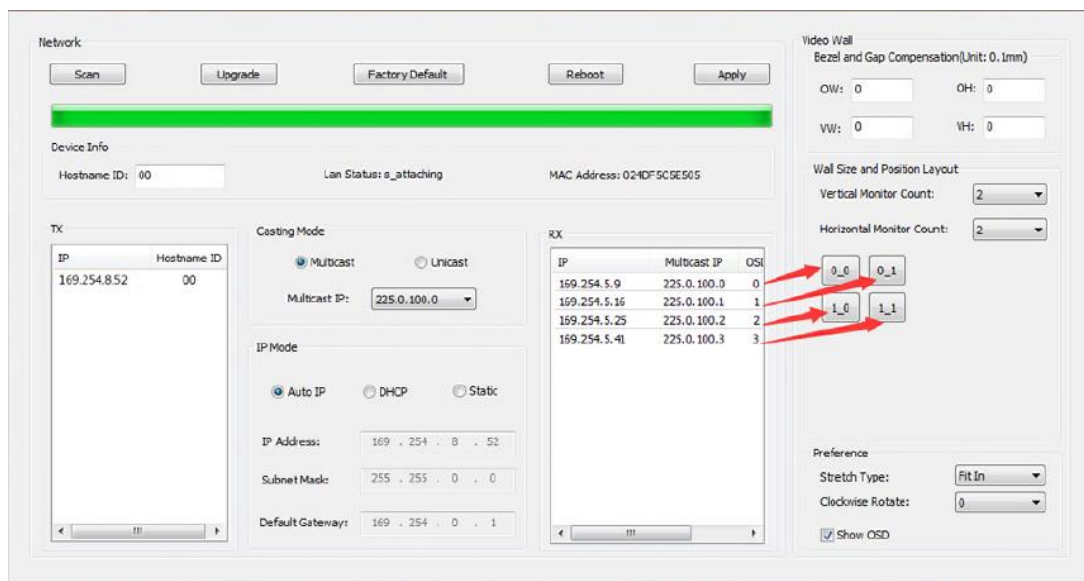

Press "Apply" to confirm.

11 CONFIGURATION USING THE WEB INTERFACE

VEO devices can also be configured through their own built-in web interface, by simply typing the IP address of the device into a web browser (Google Chrome recommended).

Refer to the '[How to find out the IP address of devices](#)' chapter to find the device's IP address, and make sure that the network card of your PC is configured within the same network domain as the VEO devices.

Once you have opened the web page, it will display 4 different configuration tabs: "System", "Video Wall", "Network" and "Functions".

11.1 Configuring the system settings

11.1.1 [Firmware information and updating](#)

The "System" tab includes "Version Information", which displays the firmware version and, in addition, product-related information. In the event that you need a firmware update, please contact Ecler technical support.



11.1.2 [Utilities](#)

The "Utilities" tab allows you to restore the device to factory default settings, or to reset the unit from the remote control. It is also possible to test the API commands through the API command line console.

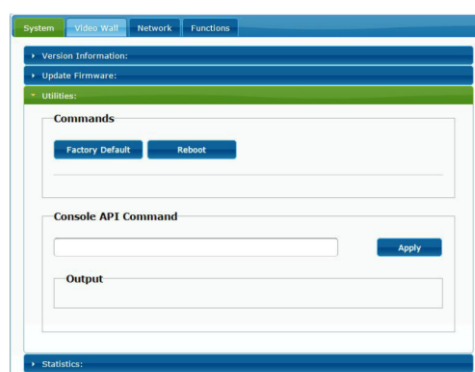

11.1.3 Statistics

This tab displays more information, such as equipment status, network settings, and information regarding video resolution and timing.

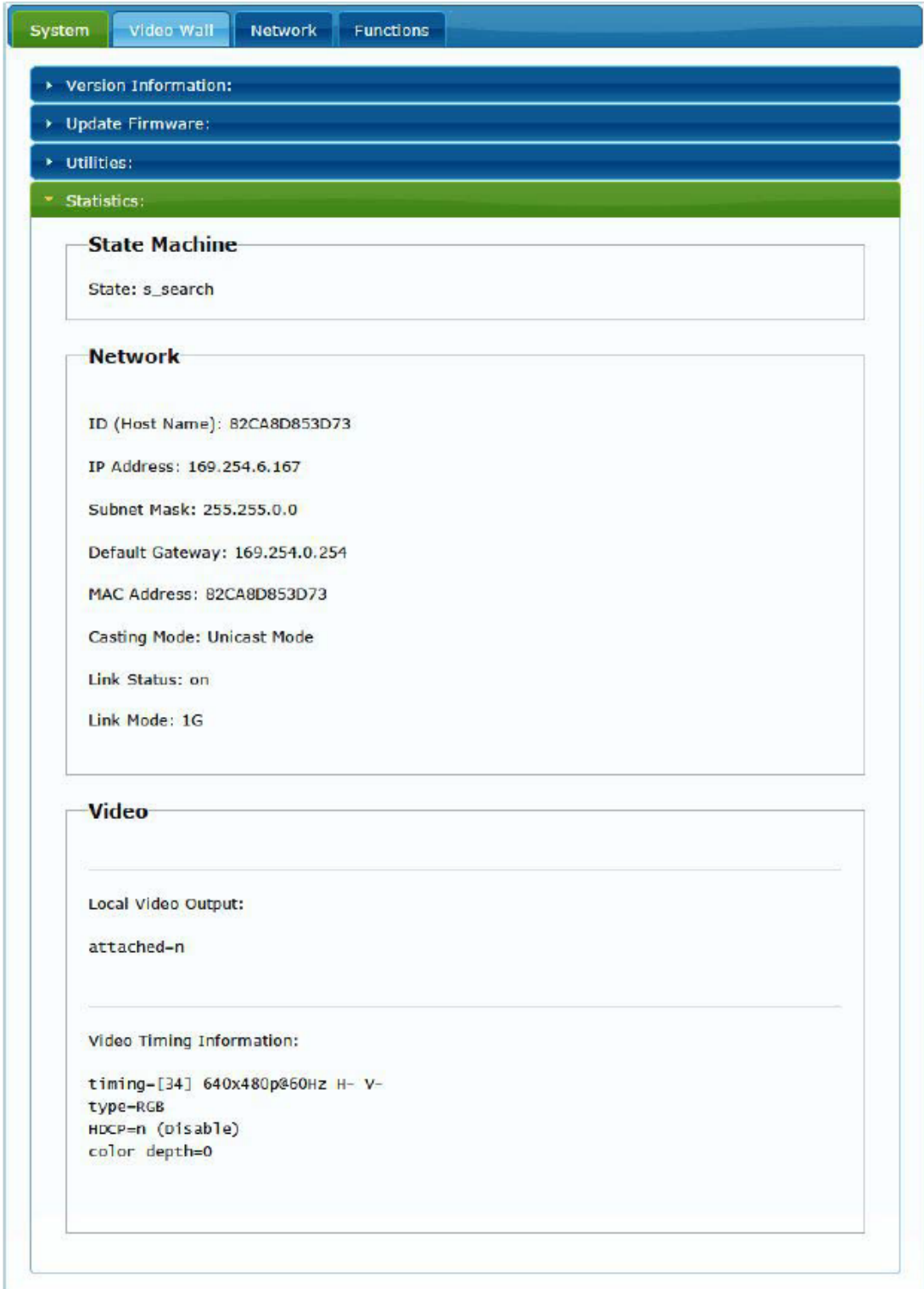

The screenshot displays the 'Statistics' tab in the ecler web interface. The navigation bar at the top includes 'System', 'Video Wall', 'Network', and 'Functions'. The 'Statistics' section is expanded, revealing three sub-sections:

- State Machine**: Shows the current state as 's_search'.
- Network**: Displays network configuration details:
 - ID (Host Name): 82CA8D853D73
 - IP Address: 169.254.6.167
 - Subnet Mask: 255.255.0.0
 - Default Gateway: 169.254.0.254
 - MAC Address: 82CA8D853D73
 - Casting Mode: Unicast Mode
 - Link Status: on
 - Link Mode: 1G
- Video**: Shows video output and timing information:
 - Local Video Output: attached-n
 - Video Timing Information: timing-[34] 640x480p@60Hz H- V- type-RGB HDCP=n (Disable) color depth=0

11.2 Configuring video wall mode using the web interface

11.2.1 Basic configuration procedure

The video wall configuration includes "Basic" and "Advanced" configurations. Under "Basic Setup", the main settings for putting together the video wall are provided. Through this page, you can set the size of the video wall structure (transmitter and receiver must be set to the same size), the position of the screen, the bezel and gap compensation and the rotation or stretching of the screen.

You need to select this device, "This", at the bottom of the page in order to control the current device. It is possible to control multiple devices from the same page by selecting the corresponding OSD/IP address, as explained below.

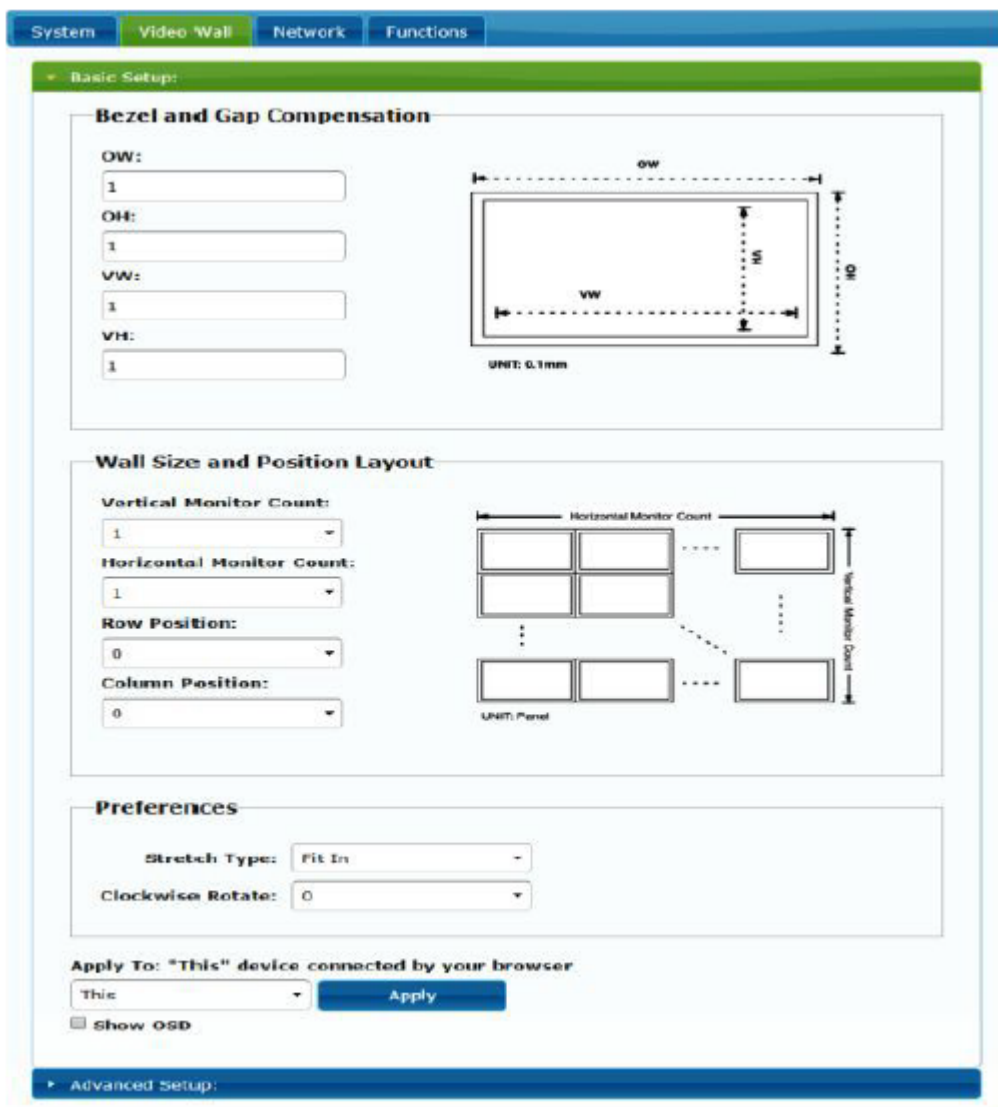

The screenshot displays the "Basic Setup" configuration page for a video wall. The interface includes a navigation bar with tabs for "System", "Video Wall", "Network", and "Functions".

Basic Setup:

- Bezel and Gap Compensation:**
 - OW:
 - OH:
 - VW:
 - VH:
- Diagram:** A diagram showing a rectangular panel with dimensions OW (Outer Width), OH (Outer Height), VW (View Width), and VH (View Height). The unit is specified as 0.1mm.

Wall Size and Position Layout:

- Vertical Monitor Count:
- Horizontal Monitor Count:
- Row Position:
- Column Position:
- Diagram:** A diagram showing a grid of monitors with labels for Horizontal Monitor Count and Vertical Monitor Count. The unit is specified as Panel.

Preferences:

- Stretch Type:
- Clockwise Rotate:

Apply To: "This" device connected by your browser

Show OSD

Advanced Setup:

11.2.2 Bezel and gap compensation:

Screen dimensions (inside and outside width and height)

- **OW:** outside width
- **OH:** outside height
- **VW:** visible width
- **VH:** visible height

1. The visible width must be less than the outside width, and the visible height must be less than the outside height
2. If the installer does not need to use these settings, all the values can simply be set to 1
3. The unit is 0.1mm, and the value must be an integer

Bezel and Gap Compensation

OW:

OH:

VW:

VH:

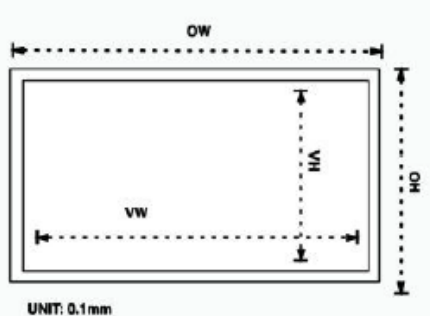

UNIT: 0.1mm

11.2.3 Size of the structure and position layout

You need to select the number of vertical and/or horizontal monitors, the position of the rows and the position of the columns. The horizontal and vertical monitor number must be included, and it should be between 1 and 8.

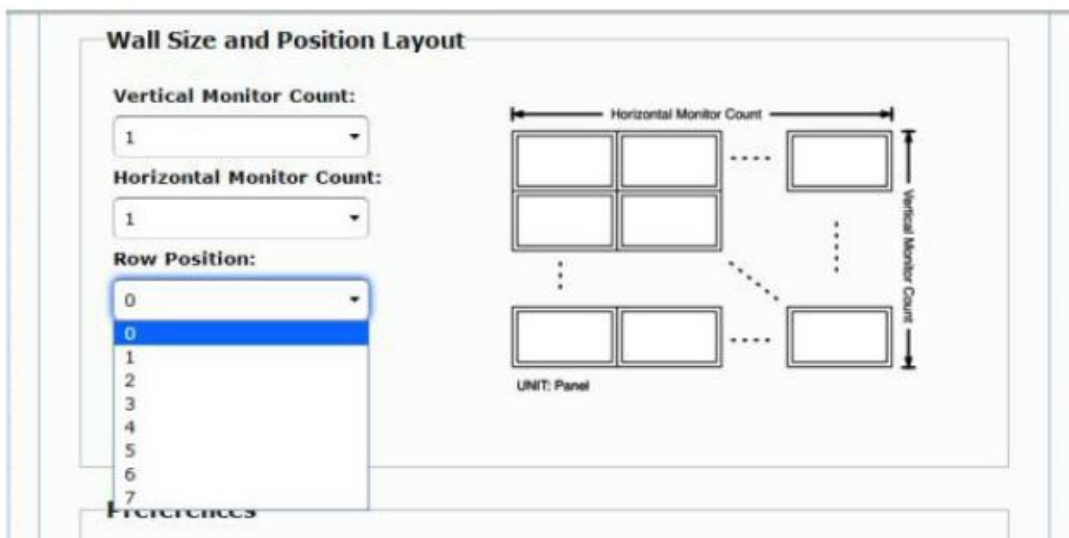
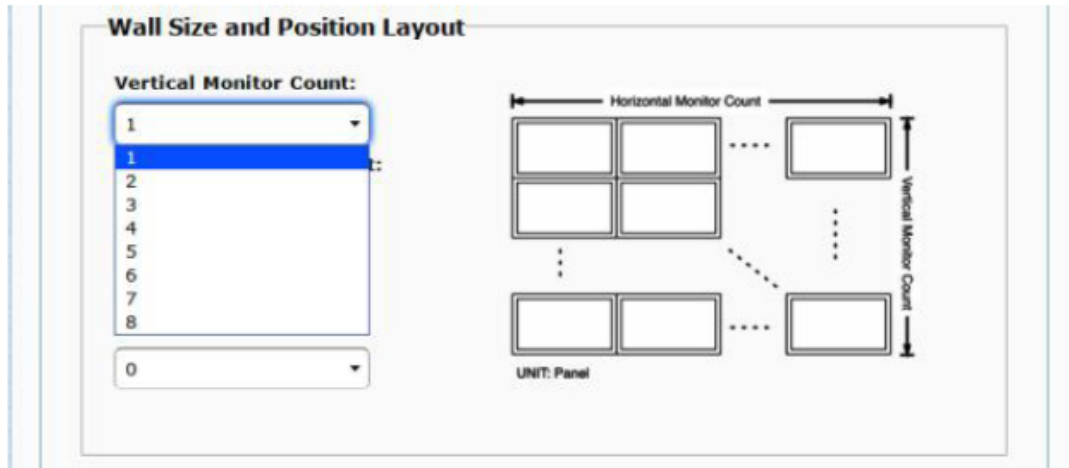

Wall Size and Position Layout

Vertical Monitor Count:

Horizontal Monitor Count:

Row Position:

Column Position:

0
 1
 2
 3
 4
 5
 6
 7
 8
 9
 10
 11
 12
 13
 14
 15

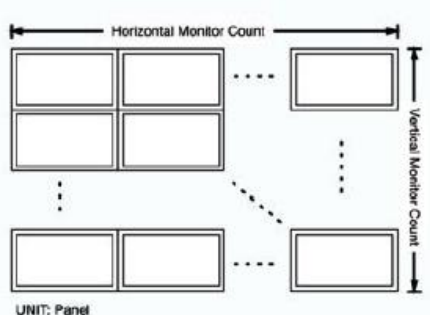

UNIT: Panel

connected by your browser

Apply

11.2.4 Preferences

Select the video stretching and rotation option. The image can fit within the screen, or be stretched and rotated through 180 or 270 degrees.

Preferences

Stretch Type:

Clockwise Rotate:

Preferences

Stretch Type:

Clockwise Rotate:

0
 180
 270

Apply To: "This" device connected by your browser

Apply

11.2.5 Apply to

- **All:** Configures all transmitters and receivers within the same IP group
- **This (Local):** Configures the current device (IP address indicated in the web browser)
- **Hosts or Clients:** selects the transmitter or receiver that is to be configured from the web page in use

Preferences

Stretch Type: ▼

Clockwise Rotate: ▼

Apply To: "All" device(s) in the list

All	Apply
This	
Hosts: 0000:169.254.10.103	
Clients: 0:169.254.4.78	

- **Show OSD:**

Select this box to display the specific OSD number for the receiver on the connected screen in real time

Preferences

Stretch Type: ▼

Clockwise Rotate: ▼

Apply To: "This" device connected by your browser

▼

Show OSD

▶ Advanced Setup:

11.2.6 Advanced configuration

This session allows for some additional fine tuning. Before entering "Advanced Setup", complete the "Basic Setup", defining and confirming the layout and size of the video display.

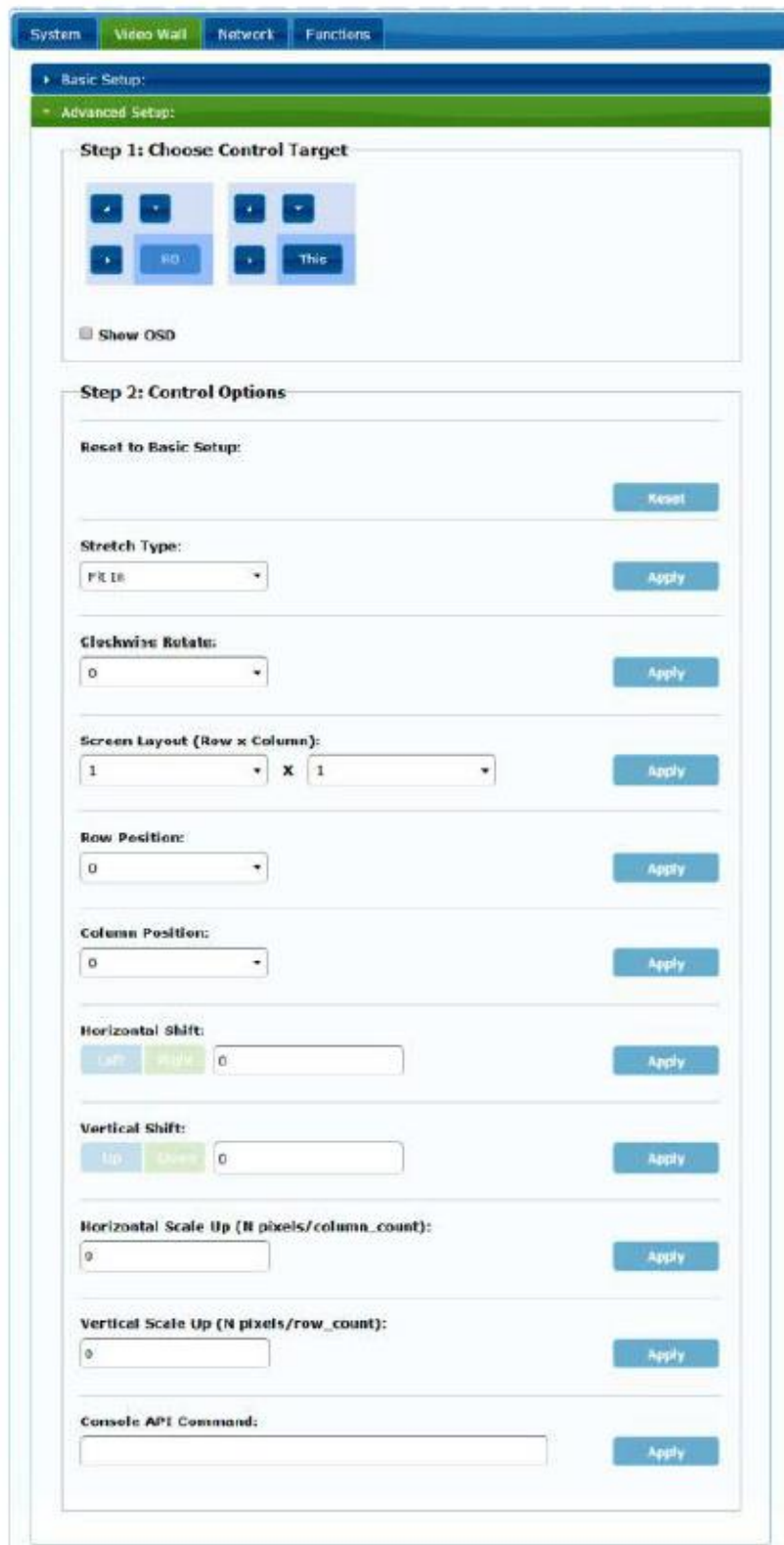

The screenshot shows a web-based configuration interface with a blue header containing tabs for 'System', 'Video Wall', 'Network', and 'Functions'. The 'Video Wall' tab is active. Below the header, there are two expandable sections: 'Basic Setup' (collapsed) and 'Advanced Setup' (expanded).

Step 1: Choose Control Target

This section contains a grid of control buttons. The top row has four buttons: left arrow, right arrow, up arrow, and down arrow. The bottom row has two buttons: 'FD' and 'This'. Below the grid is a checkbox labeled 'Show OSD'.

Step 2: Control Options

This section contains several configuration options, each with an 'Apply' button:

- Reset to Basic Setup:** A 'Reset' button.
- Stretch Type:** A dropdown menu set to 'Fit', with an 'Apply' button.
- Clockwise Rotate:** A dropdown menu set to '0', with an 'Apply' button.
- Screen Layout (Row x Column):** Two dropdown menus set to '1' and '1', with an 'Apply' button.
- Row Position:** A dropdown menu set to '0', with an 'Apply' button.
- Column Position:** A dropdown menu set to '0', with an 'Apply' button.
- Horizontal Shift:** A 'Left' button, a 'Right' button, and a text input field set to '0', with an 'Apply' button.
- Vertical Shift:** An 'Up' button, a 'Down' button, and a text input field set to '0', with an 'Apply' button.
- Horizontal Scale Up (N pixels/column_count):** A text input field set to '0', with an 'Apply' button.
- Vertical Scale Up (N pixels/row_count):** A text input field set to '0', with an 'Apply' button.
- Console API Command:** A text input field, with an 'Apply' button.

If a 3x5 video structure is required, for example, once the basic configuration has been applied, the first advanced configuration session will look like this. You can make changes to a group of screens by simply selecting the target devices.

Wall Size and Position Layout

Vertical Monitor Count:

Horizontal Monitor Count:

Row Position:

Column Position:

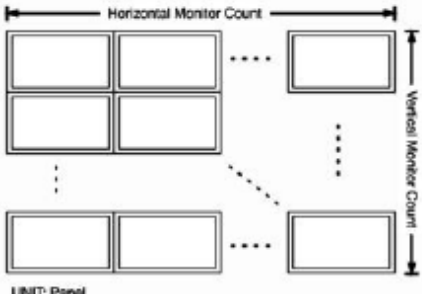

Step 1: Choose Control Target

⬅	⬇	⬅	⬇	⬅	⬇	⬅	⬇	⬅	⬇
➡	R0	➡	This	r0c1	r0c2	r0c3	r0c4	➡	
➡	R1	➡	r1c0	r1c1	r1c2	r1c3	r1c4	➡	
➡	R2	➡	r2c0	r2c1	r2c2	r2c3	r2c4	➡	

Show OSD

If there are errors in the settings, the "Reset" button will reset all advanced parameters to their default values.

Reset to Basic Setup:

The video offsetting and scaling can be adjusted through the following parameters:

Horizontal Shift:	
<input type="button" value="Left"/>	<input type="button" value="Right"/> <input type="text" value="0"/>
<input type="button" value="Apply"/>	
<hr/>	
Vertical Shift:	
<input type="button" value="Up"/>	<input type="button" value="Down"/> <input type="text" value="0"/>
<input type="button" value="Apply"/>	
<hr/>	
Horizontal Scale Up (N pixels/column_count):	
<input type="text" value="0"/>	<input type="button" value="Apply"/>
<hr/>	
Vertical Scale Up (N pixels/row_count):	
<input type="text" value="0"/>	<input type="button" value="Apply"/>

Horizontal Shift: Adjusts the horizontal shift of the video, Left or Right

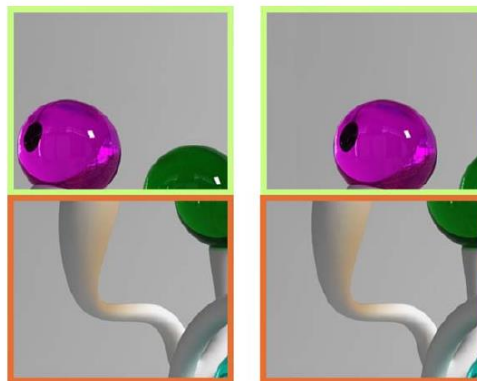

Vertical Shift: Adjusts the vertical shift of the video, Up or Down

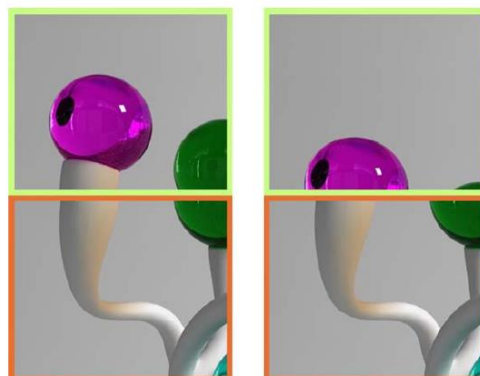

Horizontal Scale Up: Adjusts the horizontal scaling of the video up



Vertical Shift Scale Up: Adjusts the vertical scaling of the video up

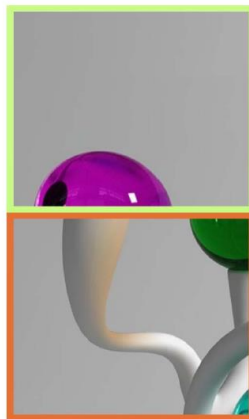

11.3 Configuring network settings

The "Network" page allows you to adjust the network settings and casting mode for each device.

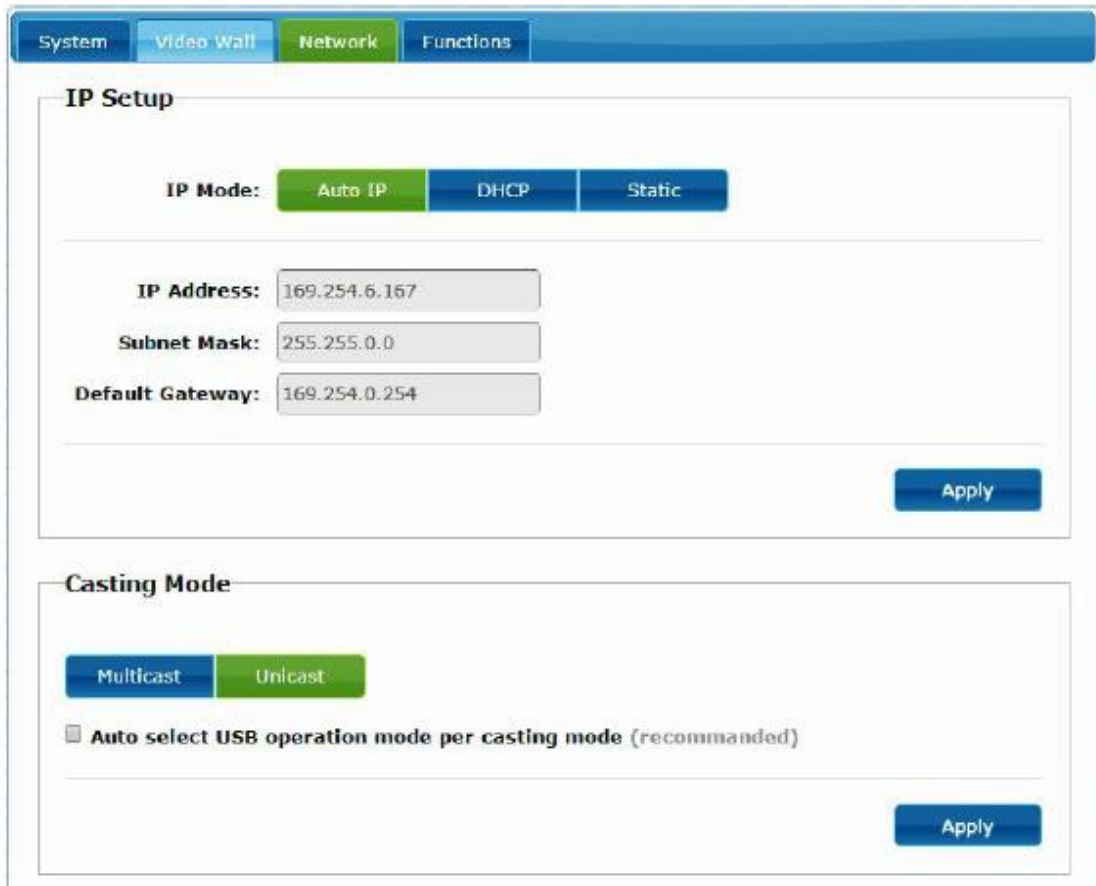

The screenshot shows the "Network" configuration page with the following sections:

- IP Setup:**
 - IP Mode:** Radio buttons for "Auto IP" (selected), "DHCP", and "Static".
 - IP Address:** Text input field containing "169.254.6.167".
 - Subnet Mask:** Text input field containing "255.255.0.0".
 - Default Gateway:** Text input field containing "169.254.0.254".
 - Apply:** Button at the bottom right of the section.
- Casting Mode:**
 - Radio Buttons:** "Multicast" and "Unicast" (selected).
 - Checkbox:** "Auto select USB operation mode per casting mode (recommended)".
 - Apply:** Button at the bottom right of the section.

11.3.1 Auto IP

Auto IP (default) enables automatic IP address assignment when more devices are connected to the same network. The factory-assigned IP subnet is 169.254.x.y. The last two numbers are randomly generated within a pre-set range.



This close-up screenshot shows the "IP Setup" section with the following details:

- IP Mode:** Radio buttons for "Auto IP" (selected), "DHCP", and "Static".
- IP Address:** Text input field containing "169.254.6.167".
- Subnet Mask:** Text input field containing "255.255.0.0".
- Default Gateway:** Text input field containing "169.254.0.254".
- Apply:** Button at the bottom right.

11.3.2 DHCP (Dynamic Host Configuration Protocol)

If you are using a network switch or a LAN that has a DHCP server enabled on it, it will automatically assign a unique IP address to each device.



The image shows a screenshot of an 'IP Setup' configuration window. At the top, the title 'IP Setup' is displayed. Below the title, there are three radio button options for 'IP Mode': 'Auto IP', 'DHCP', and 'Static'. The 'DHCP' option is selected and highlighted in green. Below these options, there are three input fields: 'IP Address', 'Subnet Mask', and 'Default Gateway'. Each of these fields contains the text '(From DHCP Server)'. At the bottom right of the window, there is a blue 'Apply' button.

Refer to the instructions in the ['How to find out the IP address of devices'](#) chapter to find the IP address assigned to each device.

11.3.3 Configuring a static IP address

When static IP addresses are required, you need to change the IP address of each device manually. Once the default "Auto IP" address has been found, you can access the configuration web page by simply typing the device address into a web browser. The control PC must be within the same network domain as the VEO products.

The IP configuration can be changed using the embedded web page:



After changing the default Ethernet settings, click on the "Apply" button

11.3.4 Casting Mode

Select the casting mode according to the application for which the extender is being used:

- **Multicast:** required for casting applications, matrix structures or point-to-multipoint and multipoint-to-multipoint video walls
- **Unicast:** required for point-to-point extension applications



The "Auto select USB operation mode per casting mode" allows you to change the behaviour of the USB pass-through according to the selected casting mode.

11.4 Configuring operating functions

The "Functions" page allows you to configure the video output, the USB extension mode and the "Serial over IP" function, both for the transmitter and the receiver.

The receiver page will look like this:

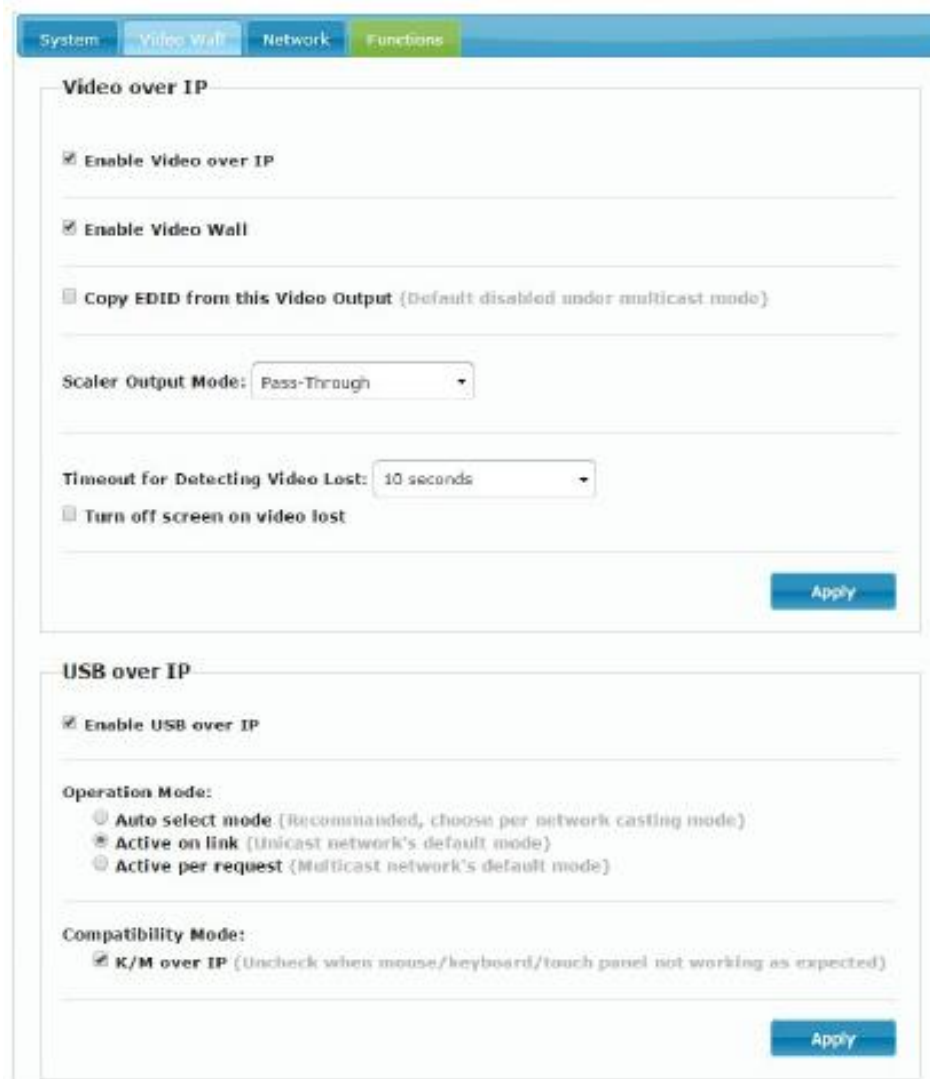

The screenshot displays the 'Functions' configuration page for a receiver. The page has a navigation bar at the top with tabs for 'System', 'Video Wall', 'Network', and 'Functions'. The 'Functions' tab is active.

Video over IP

- Enable Video over IP
- Enable Video Wall
- Copy EDID from this Video Output (Default disabled under multicast mode)
- Scaler Output Mode:
- Timeout for Detecting Video Lost:
- Turn off screen on video lost

USB over IP

- Enable USB over IP
- Operation Mode:
 - Auto select mode (Recommended, choose per network casting mode)
 - Active on link (Unicast network's default mode)
 - Active per request (Multicast network's default mode)
- Compatibility Mode:
 - K/M over IP (Uncheck when mouse/keyboard/touch panel not working as expected)

11.4.1 Setting the video output mode for the receiver

- **Enable Video over IP:** Select this box to activate Video over IP extension
- **Enable Video Wall:** Select to activate the function for putting together a video wall
- **Enable EDID Copy:** This function allows you to copy the EDID output and send the information to the Transmitter. Limited to unicast mode
- **Scaler Output Mode:** Selects the output mode for the desired scaling. Select "customize" and type in 8 hexadecimal values for greater video output resolution and refresh rate selections

For example:

1. 80000004: HD 720p60
 2. 81000061: WXGA 1366x768@60
 3. 81000040: WXGA+ 1440x900@60
 4. 81000051: WUXGA 1920x1200@60
 5. 8100003C: SXGA+ 1400x1050@60
- etc.

Timeout for Detecting Video Lost: Set the time frame for stopping video at the output once it has detected that the HDMI signal from the transmitter has been lost. The detection of the loss of video signal will depend, first of all, on the status of the "Turn off screen on video host" feature. The modes of operation are:

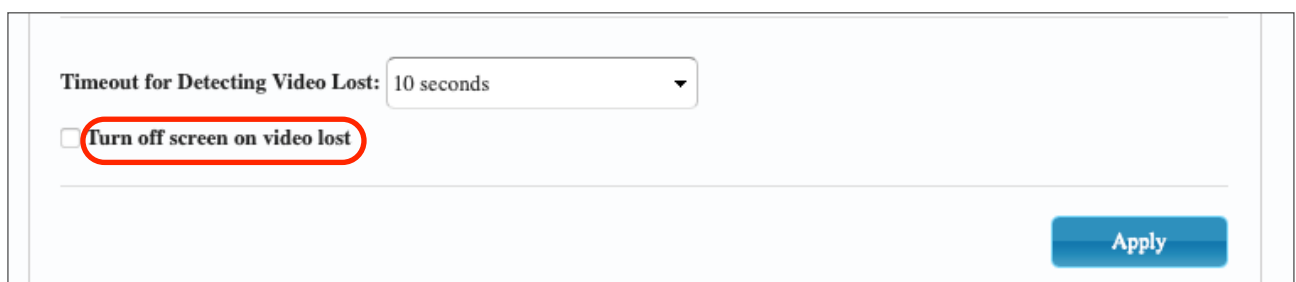

Timeout for Detecting Video Lost: 10 seconds ▼

Turn off screen on video lost

Apply

- **Not active:** if this box is not selected, the time frame entered in the "Timeout for Detecting Video Lost" parameter will define the interval between the moment when video is no longer detected and the moment when the VEO-XRI2L information screen appears

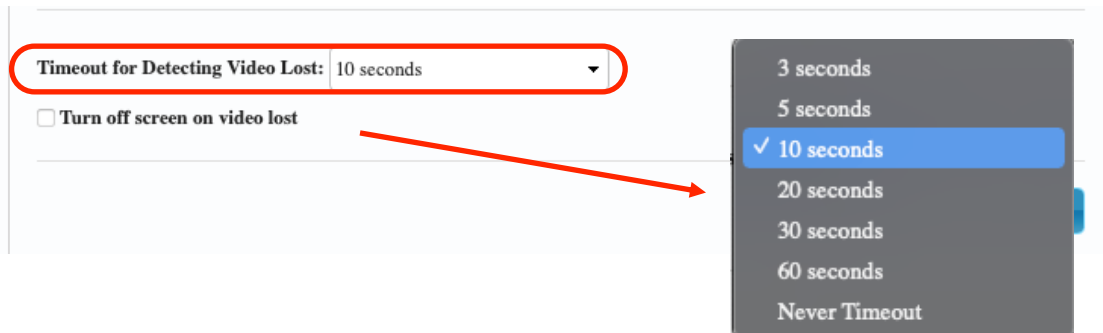

- **Active:** if this box is selected, the interval defined in the "Timeout for Detecting Video Lost" parameter will behave the same as in the previous situation. However, in this case, it will not go back to the receiver information screen, but instead, the warning indicating that a signal is not detected will appear for each screen

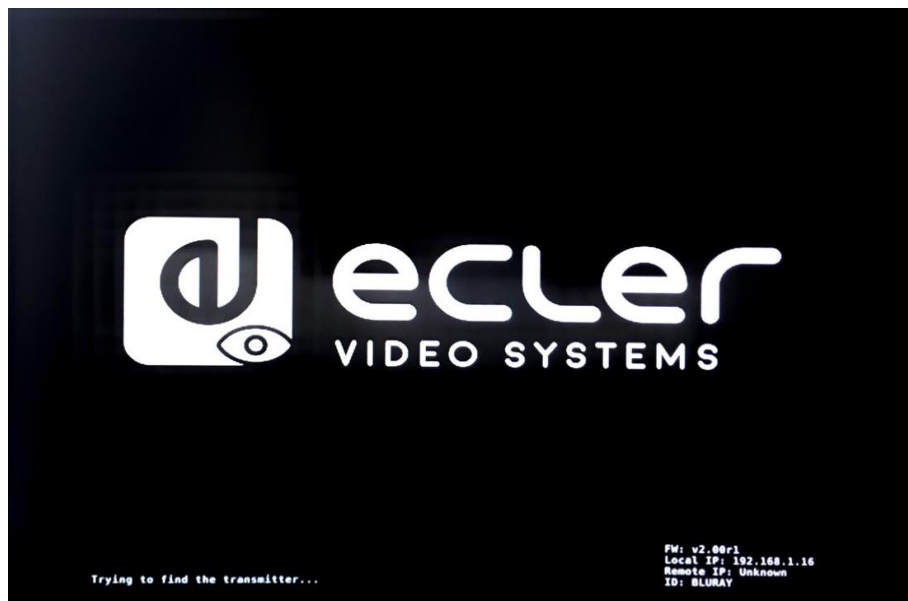

If the "Never Timeout" parameter is selected as the time frame, then the last video frame prior to the loss of video signal will be remain indefinitely, until another video stream is detected or the transmitter is restarted.

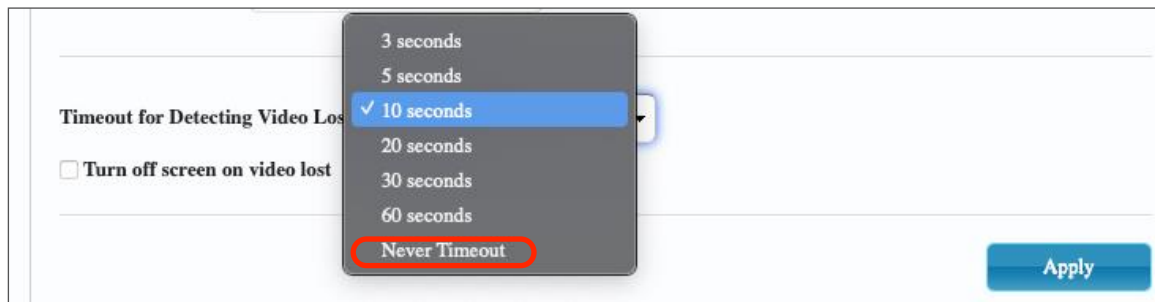

11.4.2 [Setting the scalar output mode for the transmitter](#)

On the Transmitter Function page, you can select the maximum transmission speed for the generated transmission.

It is possible to set the transmission speed at a value of 10 to 200 Mbps, with a "Best effort" option that optimizes the transmission speed according to the video input.

11.4.3 [USB over IP data extension](#)

This section allows you to select the USB extension options.

- **Enable USB over IP:** Select to enable USB over IP extension mode
- **Operating mode:**
 - **Auto select mode:** will automatically select "active on link" or "active per request", depending on the casting mode
 - **Active on link:** USB transmission from transmitter to receiver. Suggested for unicast scenarios
 - **Active per request:** if several KVM endpoints are controlling one PC, for example, the USB link will be activated on request. Suggested for multicast scenarios

- **Compatibility Mode:** Select to enable enhanced USB keyboard and mouse optimizations.



USB over IP

Enable USB over IP

Operation Mode:

Auto select mode (Recommended, choose per network casting mode)

Active on link (Unicast network's default mode)

Active per request (Multicast network's default mode)

Compatibility Mode:

K/M over IP (Uncheck when mouse/keyboard/touch panel not working as expected)

Apply

- **Serial over IP**
 - **Type 2:** allows you to extend a Full-Duplex RS232 communication from the transmitter to the receiver, when the RS232 selector for the devices is set to Normal. Other options are reserved. Once the type 2 option is selected, it will be possible to set typical serial communication parameters such as speed of transmission, data bits, parity and stop bits
 - **Type 2 guest mode:** allows the VEO-XTI2L and VEOXRI2L to act as translators of TCP/IP and RS-232 communication. To do so, you will need to create a TCP/IP connection using the device's IP address and port 6752. Once this has been created, commands sent via TCP/IP will be sent transparently, through the serial port of the VEO device

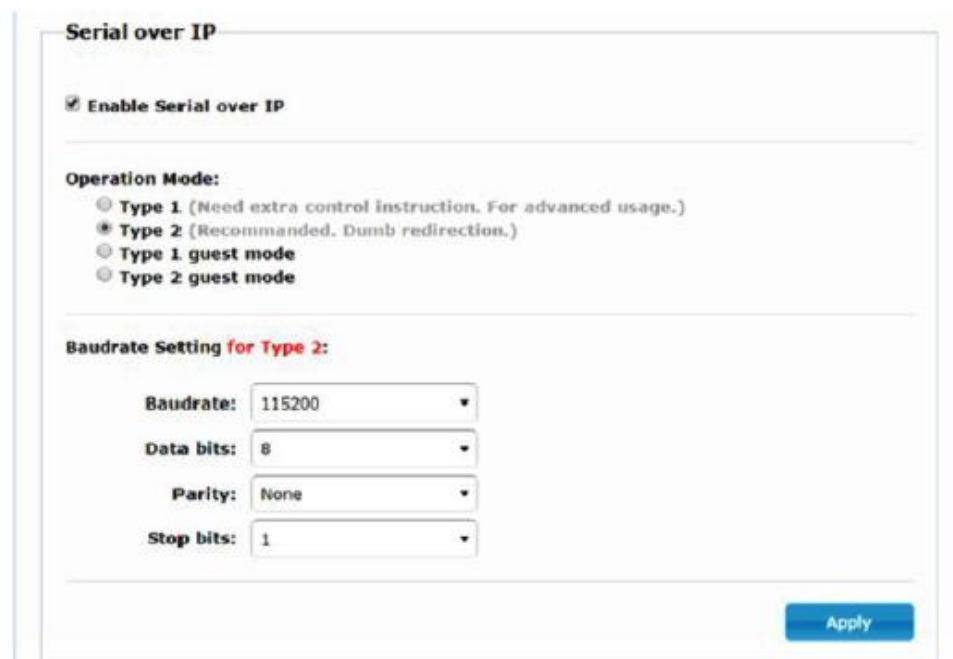

Serial over IP

Enable Serial over IP

Operation Mode:

Type 1 (Need extra control instruction. For advanced usage.)

Type 2 (Recommended. Dumb redirection.)

Type 1 guest mode

Type 2 guest mode

Baudrate Setting for Type 2:

Baudrate: 115200 ▼

Data bits: 8 ▼

Parity: None ▼

Stop bits: 1 ▼

Apply

12 FIBRE OPTIC CONNECTION

When greater extension distances than the standard Ethernet limit of 100m are required, a fibre optic link can be used instead of a Cat. 5e/6 copper link. The fibre optic link can reach distances of up to 2Km or 60Km, depending on whether multi-mode or single-mode fibre is used. For this purpose, VEO devices support standard 3.125 Gbps SFP transceiver modules (not included).

Simply insert the SFP transceiver module into the SFP receptacle in order to make the VEO devices ready for fibre connection. Once the fibre cable is connected and the link is active, the corresponding connection LED will flash, indicating that it is functioning correctly.

Note: The fibre optic connection and copper link can be active at the same time, but only one will work at a time. The connection mode that was switched on first has priority. In the event that the primary source is disconnected, the secondary source would take over immediately as the primary network link, without affecting transmission

13 FACTORY RESET

For these VEO devices, you can perform a factory reset using the VEO-XTI2L-XRI2L Control Centre (see the '[Configuration using VEO-XTI2L-XRI2L Control Centre](#)' chapter) or using the web page (see the '[Configuration using web interface](#)' chapter).

If the IP address is unknown, set the operation mode selector to Program, connect an RS-232 interface (115200, 8 N 1) and send the following command:

```
/ # lparam g MY_IP
```

followed by CR and LF chars.

Note: After the factory reset has been performed, the IP address settings will return to "Auto IP". The IP address will be restored to the "169.254.x.y" range

14 TECHNICAL SPECIFICATIONS

Resolution	3840X2160@30HZ 3840X2160@60Hz (4:2:0) supported and converted to 3840X2160@30Hz, 1080P/1080i/720P/576P/576i/480P/480i
Video connectors	HDMI 1.4 with thread lock
HDCP	2.2 Compliant
Network requirements	Accordance with IGMP and Jumbo Frames
Network transmission bit rate	Up to 300Mbps
Video latency	1 to 3 frames depending on network conditions
Network connectors	RJ45 with LED indication and SFP receptacle
Default IP	Auto IP (239.254.x.y)
PoE power operation	802.3af
Transmission distance	Up to 120m. (via CATx) in point-to-point topology; Up to 100m when connected to standard Ethernet devices; Up to 60Km via single mode fiber; Up to 2Km via multimode fiber;
Audio formats	LPCM 2.0, Dolby True HD, DTS-HD Master audio
Sampling rate	192 kHz
Bit depth	24-bit
Analog audio connectors	3.5mm stereo minijack
Digital audio connectors	S/PDIF Toslink
IR bandwidth supported	38 -56 KHz
USB ports	TX: USB 2.0 Keyboard / Mouse 1 x USB type B RX: USB 2.0 Keyboard / Mouse 2 x USB type A
RS-232 Connector	3 pins Phoenix
Operating temperature	0°C - 50°C / 32°F - 122°F
Humidity	5 - 90% RH (non-condensing)
Energy consumption	3 W MAX (TX y RX)
Input supply	AC100~240V 50/60Hz Output: DC 5V/1A
Dimensions A x A x P	26mm x 170mm x 109mm (1.02" x 6.69" x 4.29") (TX y RX)
Weight	470g (1,036 lbs.)

VEO-XTI2L / VEO-XRI2L

TCP/IP CONTROL



TCP/IP CONTROL MANUAL

15 THIRD PARTY CONTROL PROTOCOL: CONNECTION AND LOGIN

VEO-XTI2L and VEO-XRI2L can be controlled by third party devices or third party control systems via TCP/IP.

By default, transmitters and receivers come with “Auto IP” settings that provide automatic IP address assignment when more devices are connected to the same network. The default IP subnet is 169.254.x.y.

Please consult [VEO-XTI2L and VEO-XRI2L User Manual](#) in order to discover the devices connected to your LAN network and change the IP address accordingly with your network.

Once a static IP address is set, open a TCP/IP connection on **port 24** using the device IP address; the devices will send a welcome message like follows:

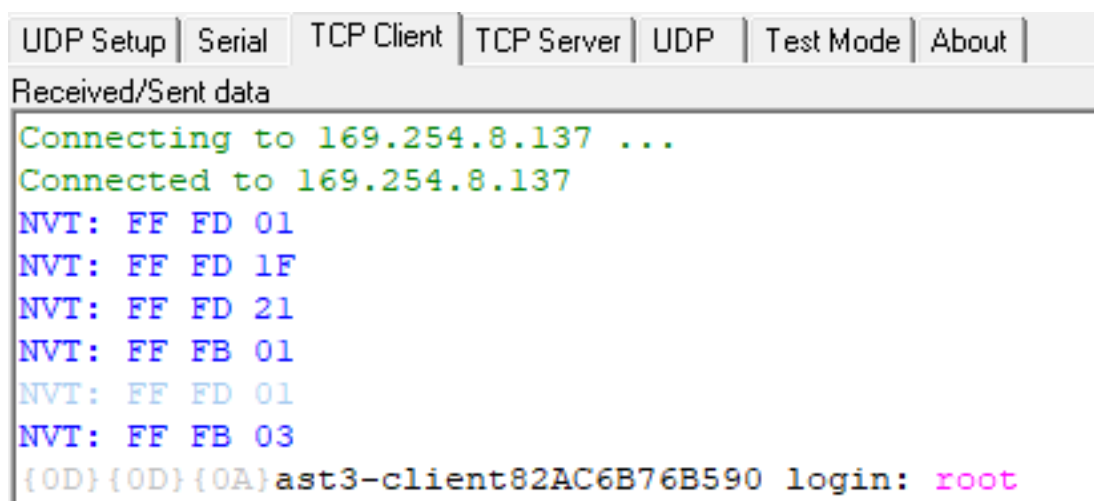

```
UDP Setup | Serial | TCP Client | TCP Server | UDP | Test Mode | About |
Received/Sent data
Connecting to 169.254.8.137 ...
Connected to 169.254.8.137
NVT: FF FD 01
NVT: FF FD 1F
NVT: FF FD 21
NVT: FF FB 01
NVT: FF FD 01
NVT: FF FB 03
{0D}{0D}{0A}ast3-client82AC6B76B590 login: root
```

After “welcome message” is sent, you can login using **root** as username (no password needed).

Once the “/ #” command prompt is shown, the device is ready to receive control commands.

After each command, a **carriage return** CR char is required (0x0D in hex).

16 CONTROL COMMANDS

In a typical installation scenario where multiple transmitters and receivers are connected to the network, each transmitter creates a multicast video stream on a predefined channel (displayed on the front panel display). Please remember to change the casting mode in multicast (default is unicast).

Each transmitter must be set on a different channel and the receivers can receive one of the streams just selecting the correspondent channel. The following commands are all intended for **VEO-XR12L receivers**.

16.1 SET Channel:

- `e e_reconnect::0002`

This command, sent to a receiver, allows to select a streaming channel (02 in this case). All the services active on the transmitter set on channel 02 are extended to the receiver.

16.2 SET Channel for a specific service:

Using the following commands it is possible to create independent routing of different services. For example, a receiver can receive a video stream from the transmitter set on channel 01 and a audio stream from the transmitter set as channel 02.

- `e e_reconnect::0001::v`
- `e e_reconnect::0002::a`

Each service can be specified as follows:

- **a:** audio over IP
- **v:** video over IP
- **s:** serial over IP
- **r:** IR over IP
- **u:** USB over IP

e e_reconnect::0001 will restart all the services from the same transmitter (channel 01 in this case).

NOTE: Display indication on the front panel of receivers follows the channel selected for video service.

16.3 GET channel for a specific service

- Imparam g CH_SELECT_S

This command allows getting the channel number of a specific service (RS-232 in the example). The services can be specified as follows:

- **A:** audio over IP
- **V:** video over IP
- **S:** RS-232 over IP
- **R:** IR over IP
- **U:** USB over IP

After sending **e e_reconnect::0002** without specifying any service, all the services will answer 0002.

16.4 SET Stop_link command:

- e e_stop_link

This command allows to stop all the services on a receiver. It is possible to stop a specific service by choosing between the following:

- **a:** audio over IP
- **v:** video over IP
- **s:** RS-232 over IP
- **r:** IR over IP
- **u:** USB over IP

For example:

- e e_stop_link::ru

It stops IR and USB services on the receiver.

16.5 SET reconnect command

- e e_reconnect

This command allows restarting all the services on a receiver. It is possible to start a specific service by choosing between the following:

1. **a:** audio over IP
2. **v:** video over IP
3. **s:** RS-232 over IP
4. **r:** IR over IP
5. **u:** USB over IP

For example:

- e e_reconnect::0010::ru

It restarts IR and USB services from transmitter 10 on a receiver.

16.6 SET HDMI Output ON command

- echo 0 > /sys/devices/platform/display/screen_off

It switches HDMI out ON.

16.7 SET HDMI Output OFF command

- echo 1 > /sys/devices/platform/display/screen_off

It switches HDMI out OFF.

16.8 SET Video stream Pause ON

- echo 1 > /sys/devices/platform/videoip/pause

It allows freezing the video stream to the last frame shown before sending the command.

16.9 SET Video stream Pause OFF

- echo 0 > /sys/devices/platform/videoip/pause

It allows restoring the normal video streaming reception.

16.10 Reboot command

- reboot

It allows to reboot the devices from remote. This command can be used both for **transmitters** and **receivers**.

17 VIDEO WALL COMMANDS

The following set of commands allows creating and managing a video wall system. Each screen that composes a video wall, needs to be connected to a VEO-XRI2L.

Each receiver **must** be set as “multicast” mode before sending the following commands (please check VEO-XTI2L VEO-XRI2L user manual, chapter [Multipoint-to-multipoint connections and operations](#)).

Screens are numbered as *row_column* from 0 to N-1, where N is the total number of screens per row and per column (max 8x8). This example shows the required commands to send to each receiver in order to create a 2x2 video wall:

<ul style="list-style-type: none"> • e e_reconnect::0001 • e e_vw_enable_1_1_0_0 <p style="text-align: right;">0_0</p>	<ul style="list-style-type: none"> • e e_reconnect::0001 • e e_vw_enable_1_1_0_1 <p style="text-align: right;">0_1</p>
<ul style="list-style-type: none"> • e e_reconnect::0001 <p>e e_vw_enable_1_1_1_0</p> <p style="text-align: right;">1_0</p>	<ul style="list-style-type: none"> • e e_reconnect::0001 • e e_vw_enable_1_1_1_1 <p style="text-align: right;">1_1</p>

- e e_vw_enable_1_1_0_0

This command informs the receiver about video wall size (1_1 stands for 2x2) and about its own position (0_0).

It is also possible to manage each screen individually, in order to create custom compositions. The following example shows how to obtain a Picture in Picture using the top right screen. In this case this monitor is no longer a part of the video wall and operates as an independent screen receiving another channel (0002).

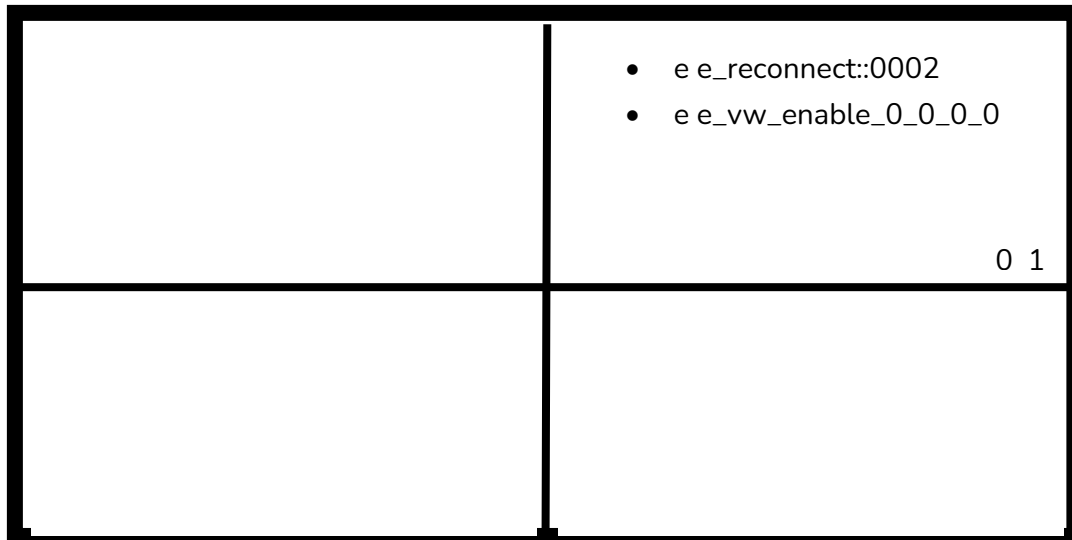

- e e_vw_enable_0_0_0_0

This command is used to switch from video wall mode to single display mode.

To return to the previous condition (video wall), simply send the previous command.

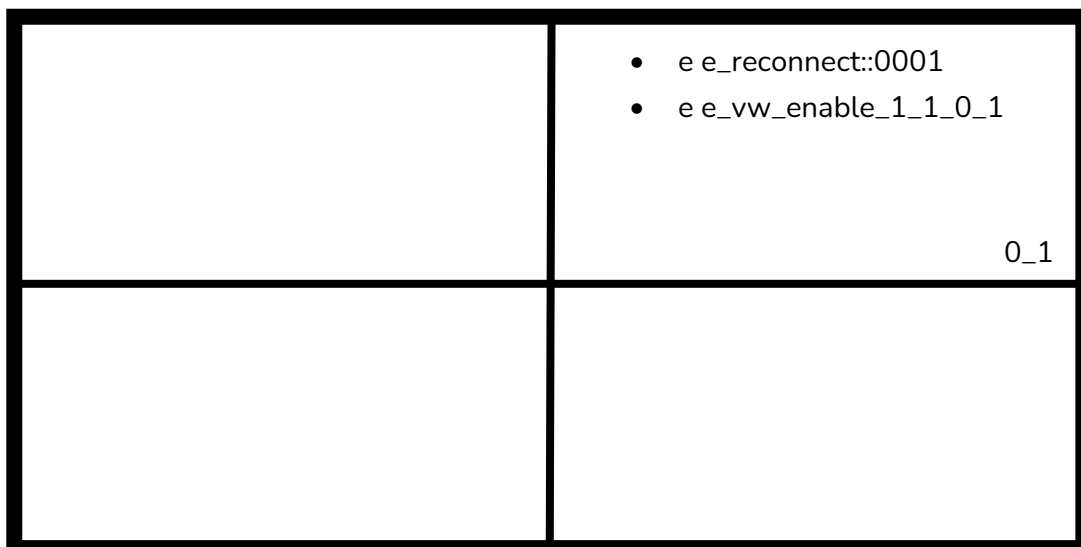

- e e_vw_rotate_5

This command allows to rotate the image by 90 degrees clockwise. The image will be automatically scaled to the new resolution (portrait mode).

- e e_vw_rotate_6

This command allows to rotate the image by 90 degrees counterclockwise. The image will be automatically scaled to the new resolution (portrait mode).

- e e_vw_rotate_3

This command allows to rotate the image by 180 degrees.

- e e_vw_rotate_0

This command allows to orient the image at normal position.

18 HOW TO USE VEO-XTI2L and VEO-XRI2L as a TCP/RS232 converter

The RS-232 port of the VEO-XTI2L and VEO-XRI2L devices is configured by default to perform a bidirectional RS-232 extension between transmitters and receivers.

It is however possible to use the RS-232 port of VEO-XTI2L and VEOXRI2L extenders as a control port for third-party devices, just sending the desired command via TCP / IP and using the VEO devices as protocol translators.

To activate this feature it is necessary to change the serial port default settings through VEO device control web page.

Once the IP address of the device has been discovered (see "[How to find out the IP address of devices](#)"), open the *Functions* page and on "Serial over IP" change the "Operation mode" option from "Type 2" to "**Type 2 guest mode**".

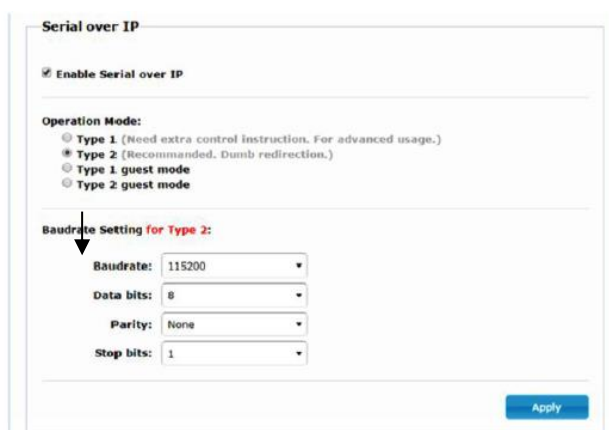

After pressing the "Apply" button and rebooting the device, it is necessary to create a TCP/IP connection using **device IP address** and **port 6752**.

Once the connection is created, commands sent via TCP / IP will be forwarded in transparent mode through the serial port of VEO device.

19 HOW TO SEND CONTROL COMMANDS USING ECLERNET MANAGER

All the commands described above can be sent via 3rd party control systems or using the User Control Panels (UCP) on Ecler Net Manager.

The different options of control that include touch screens and mobile device, allow creating a very user friendly and cost effective control system.

Here below some examples about how to send control commands to VEO-XRI2L receiver devices using Net Strings Buttons on Ecler Net Manager.

19.1 Ecler Net Manager Net String Syntax

When a Net String Button is used in ENM, the typical TCP command is structured like follows:

```
|tcp|192.168.1.19|24|\d1root\r e_reconnect::0002\r\d1|
```

|tcp|: indicates the type of communication. The two available options are **tcp** or **udp**: VEO devices only accept TCP connection,

|192.168.1.19|: indicates the IP address of the device to control (TCP server).

|24|: indicates the port of the TCP socket or UDP port.

\d1: this string is used to introduce a time delay multiple of 100mS in sequences of commands. In this case it is necessary to introduce a delay before the login in order to wait that the “welcome message” is finished. It is also needed before the connection is closed to ensure that all the commands have been received.

```
\d1=\D1=100mS
```

```
\d9=\D9=900mS
```

```
\d9\d3=\D9\D3=1200mS
```

root: login username. Specific username for VEO-XRI2L devices (no password needed).

\r: **CR Carriage Return** command; it is equal to **\x0D** in hex.

e e_reconnect::0002 VEO-XRI2L command to set the receiving channel (02).

Other useful chars are:

- \n** **LF** *Line Feed* that is equal to \x0A in hex.
- \0** **NUL** *Null char* that is equal to \x00 in hex.
- \xHH=\XHH** the sequence **\x** allows to send commands in hexadecimal code. HH are two hex digits.
- ** sending this sequence is equal to send a \ char.
- space** **STX** *Start of text* char; \x02 in hex.

19.2 Ecler Net Manager Net String Examples

- Set receiving channel 03:

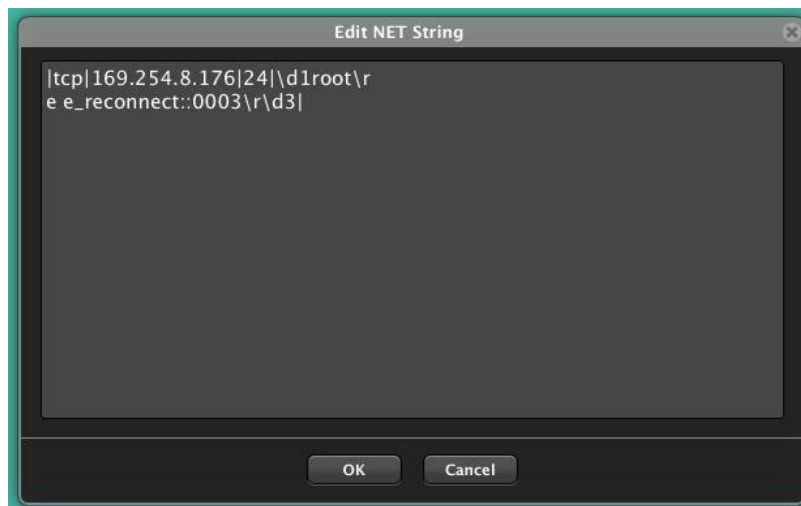

- Create a video wall 1x2 receiving source channel 03:

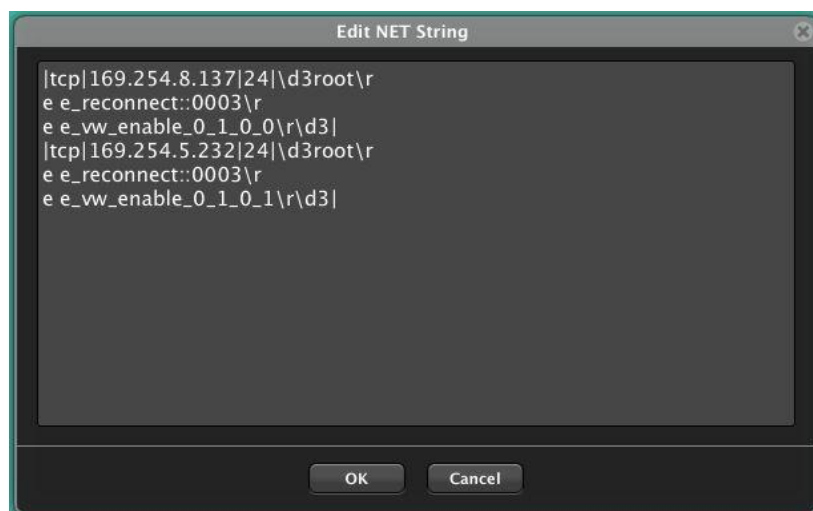

- Restore one of the screen as independent screen receiving channel 03:

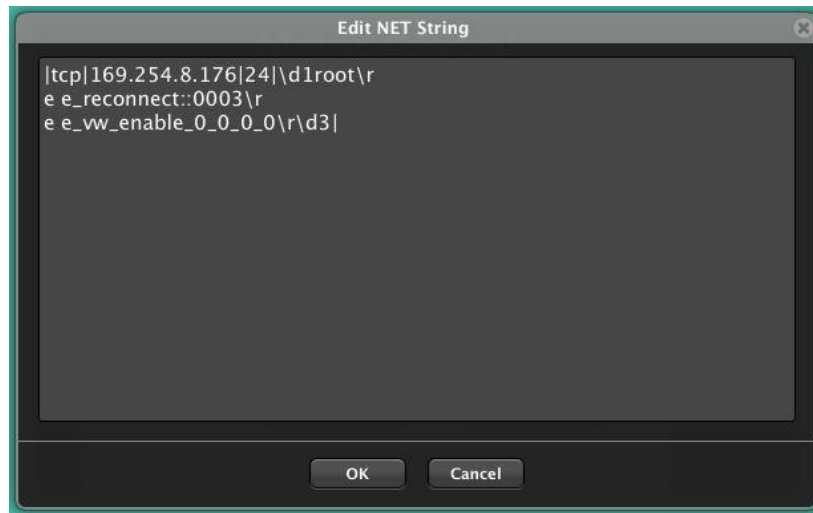

- Send a RS-232 “PoweON” command followed by CR and LF commands to a 3rd party device through the receiver RS-232 port:

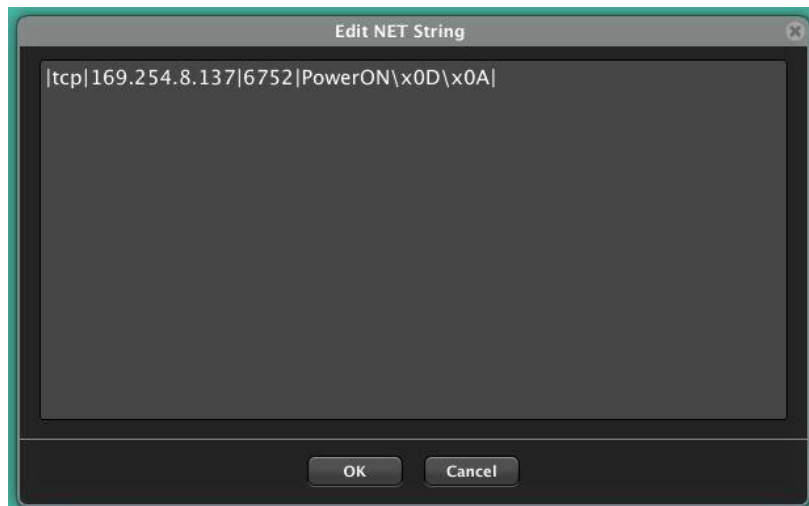

VEO-XTI1C / VEO-XRI1C VEO-XTI2L / VEO-XRI2L

How to configure a Cisco SG300 Ethernet Switch for Ecler VEO over IP products



QUICK START GUIDE

20 HOW TO CONFIGURE A CISCO SG300 ETHERNET SWITCH INTRODUCTION

Due to the network requirements established by Audinate® for Dante™ Networks and taking in consideration the network requirements for our VEO over IP devices, this quick guide aims to explain how to configure the Cisco SG300 family of switches in order to make them compliant to these requirements. All the requirements are mandatory for every switch used in a Dante or VEO over IP system, independently by the brands.

21 ESTABLISHING COMMUNICATION WITH THE CISCO ETHERNET SWITCH

1. Connect your computer to the Cisco Ethernet Switch using an Ethernet cable. The Cisco SG300 Ethernet Switch comes with a default Static IP address of **192.168.1.254**; you must configure your PC with a Static IP address in the same subnet.
2. Set a Static IP address on your computer network interface card, such as 192.168.1.66 along with the following mask 255.255.255.0.
3. Open your Internet browser and digit the default IP address of the switch: <http://192.168.1.254>. The **Default User ID** and **Password** for the unit is "Cisco".

22 ENABLING IGMP PROTOCOL

The IGMP Protocol is mandatory for the correct operation of the VEO over IP products in multicast configurations. Without IGMP the audio/video can't work properly or may freeze.

1. Select **Multicast** → **Properties**. Enable the **Bridge Multicast Filtering Status** by activating the related selection box and clicking on **Apply**.

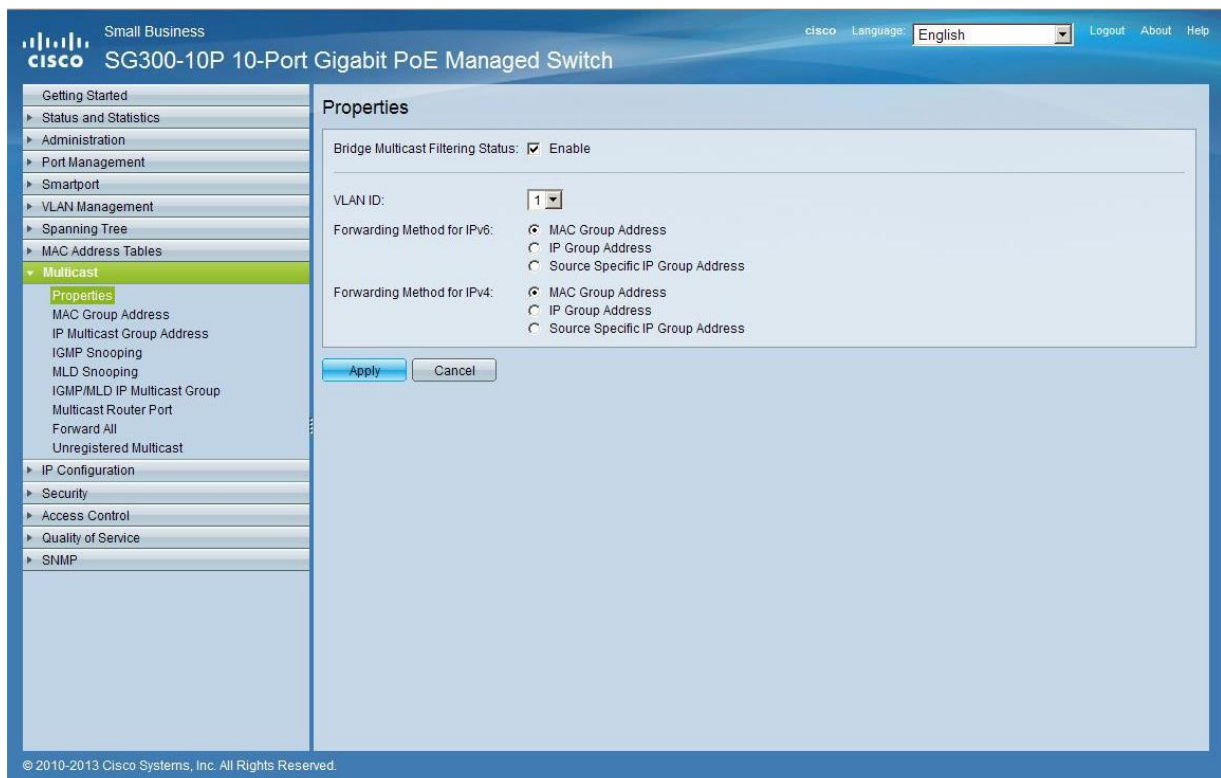

Small Business
cisco Language: English Logout About Help

SG300-10P 10-Port Gigabit PoE Managed Switch

Getting Started
Status and Statistics
Administration
Port Management
Smartport
VLAN Management
Spanning Tree
MAC Address Tables
Multicast
Properties
MAC Group Address
IP Multicast Group Address
IGMP Snooping
MLD Snooping
IGMP/MLD IP Multicast Group
Multicast Router Port
Forward All
Unregistered Multicast
IP Configuration
Security
Access Control
Quality of Service
SNMP

Properties

Bridge Multicast Filtering Status: Enable

VLAN ID: 1

Forwarding Method for IPv6:
 MAC Group Address
 IP Group Address
 Source Specific IP Group Address

Forwarding Method for IPv4:
 MAC Group Address
 IP Group Address
 Source Specific IP Group Address

Apply Cancel

© 2010-2013 Cisco Systems, Inc. All Rights Reserved.

2. Select **Multicast** → **IGMP Snooping**. Enable the **IGMP Snooping Status** by activating the related selection box and clicking on **Apply**.

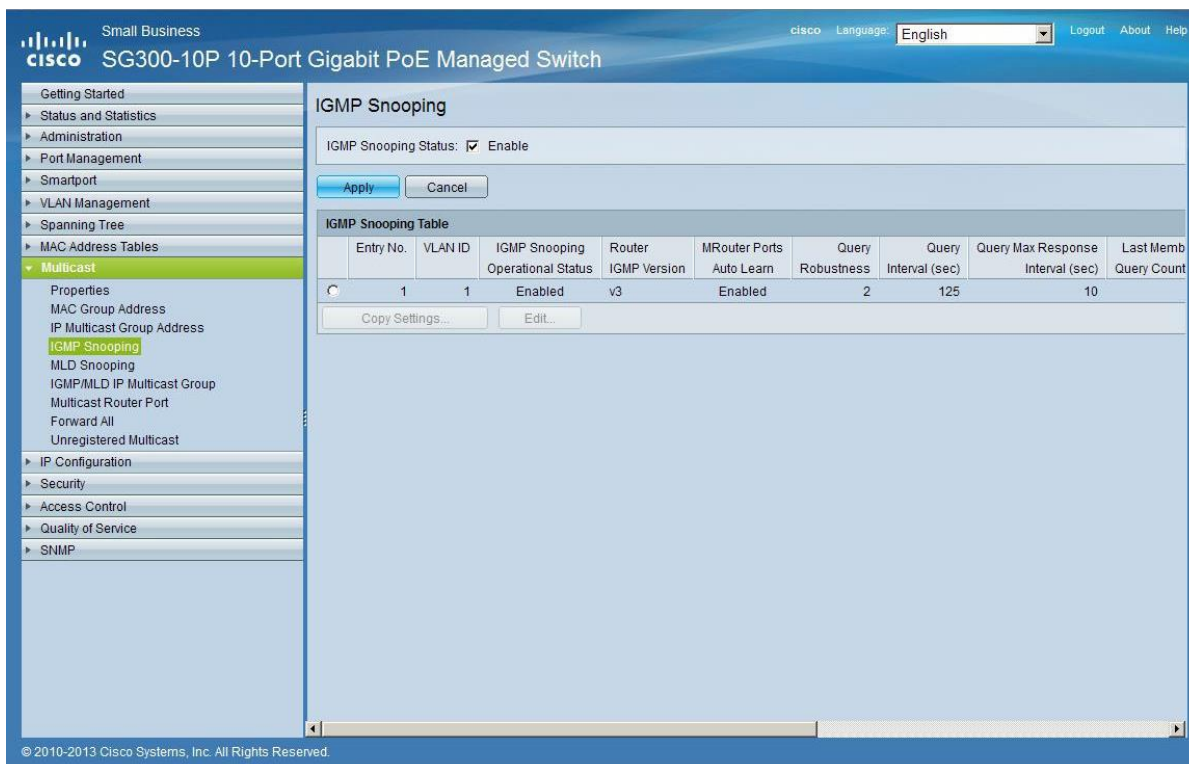

Small Business
cisco Language: English Logout About Help

SG300-10P 10-Port Gigabit PoE Managed Switch

Getting Started
 ▶ Status and Statistics
 ▶ Administration
 ▶ Port Management
 ▶ Smartport
 ▶ VLAN Management
 ▶ Spanning Tree
 ▶ MAC Address Tables
 ▼ **Multicast**
 Properties
 MAC Group Address
 IP Multicast Group Address
IGMP Snooping
 MLD Snooping
 IGMP/MLD IP Multicast Group
 Multicast Router Port
 Forward All
 Unregistered Multicast
 ▶ IP Configuration
 ▶ Security
 ▶ Access Control
 ▶ Quality of Service
 ▶ SNMP

IGMP Snooping

IGMP Snooping Status: Enable

Apply Cancel

IGMP Snooping Table

Entry No.	VLAN ID	IGMP Snooping Operational Status	Router IGMP Version	MRouter Ports Auto Learn	Query Robustness	Query Interval (sec)	Query Max Response Interval (sec)	Last Memb Query Count
1	1	Enabled	v3	Enabled	2	125	10	

Copy Settings... Edit...

© 2010-2013 Cisco Systems, Inc. All Rights Reserved.

3. In the **IGMP Snooping Table**, select the default **VLAN ID 1** and click on **Edit**.

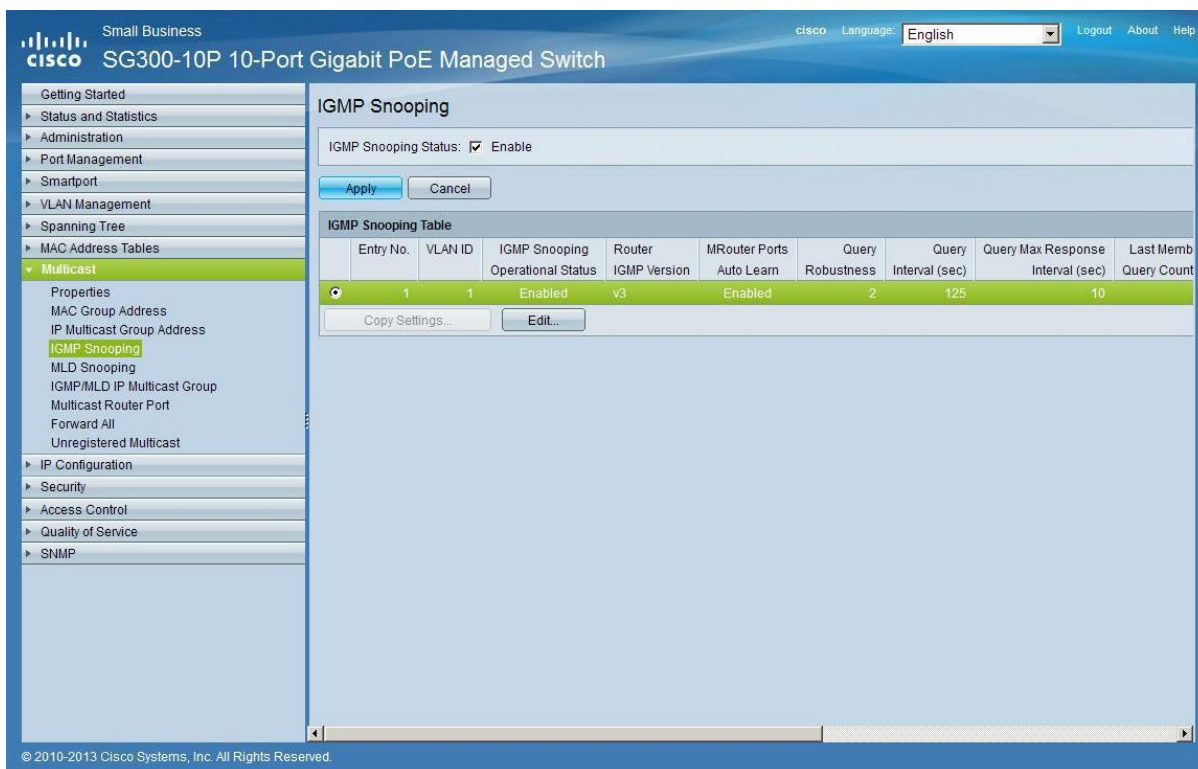

Small Business
cisco Language: English Logout About Help

SG300-10P 10-Port Gigabit PoE Managed Switch

Getting Started
 ▶ Status and Statistics
 ▶ Administration
 ▶ Port Management
 ▶ Smartport
 ▶ VLAN Management
 ▶ Spanning Tree
 ▶ MAC Address Tables
 ▼ **Multicast**
 Properties
 MAC Group Address
 IP Multicast Group Address
IGMP Snooping
 MLD Snooping
 IGMP/MLD IP Multicast Group
 Multicast Router Port
 Forward All
 Unregistered Multicast
 ▶ IP Configuration
 ▶ Security
 ▶ Access Control
 ▶ Quality of Service
 ▶ SNMP

IGMP Snooping

IGMP Snooping Status: Enable

Apply Cancel

IGMP Snooping Table

Entry No.	VLAN ID	IGMP Snooping Operational Status	Router IGMP Version	MRouter Ports Auto Learn	Query Robustness	Query Interval (sec)	Query Max Response Interval (sec)	Last Memb Query Count
1	1	Enabled	v3	Enabled	2	125	10	

Copy Settings... Edit...

© 2010-2013 Cisco Systems, Inc. All Rights Reserved.

- In the resulting window, activate the related selection box for **IGMP Snooping Status** and verify that the **Immediate Leave** selection box is enabled and then click on **Apply**.

VLAN ID:	1		
IGMP Snooping Status:	<input checked="" type="checkbox"/> Enable		Operational IGMP Snooping Status: E
MRouter Ports Auto Learn:	<input checked="" type="checkbox"/> Enable		
Query Robustness:	2 (Range: 1 - 7, Default: 2)		Operational Query Robustness: 2
Query Interval:	125 sec (Range: 30 - 18000, Default: 125)		Operational Query Interval: 1
Query Max Response Interval:	10 sec (Range: 5 - 20, Default: 10)		Operational Query Max Response Interval: 1
Last Member Query Counter:	<input checked="" type="radio"/> Use Default <input type="radio"/> User Defined (Range: 1 - 7, Default: 2 (Query Robustness))		Operational Last Member Query Counter: 2
Last Member Query Interval:	1000 mS (Range: 100 - 25500, Default: 1000)		Operational Last Member Query Interval: 1
Immediate leave:	<input checked="" type="checkbox"/> Enable		
IGMP Querier Status:	<input type="checkbox"/> Enable		
Administrative Querier Source IP Address:	<input checked="" type="radio"/> Auto <input type="radio"/> User Defined 168.168.1.1		Operational Querier Source IP Address:
IGMP Querier Version:	<input checked="" type="radio"/> IGMPV2 <input type="radio"/> IGMPV3		
<input type="button" value="Apply"/> <input type="button" value="Close"/>			

- Select **Administration** → **File Management** → **Copy/Save Configuration**. Enable **Running Configuration** and **Startup Configuration** as shown below and save all changes by clicking **Apply**.

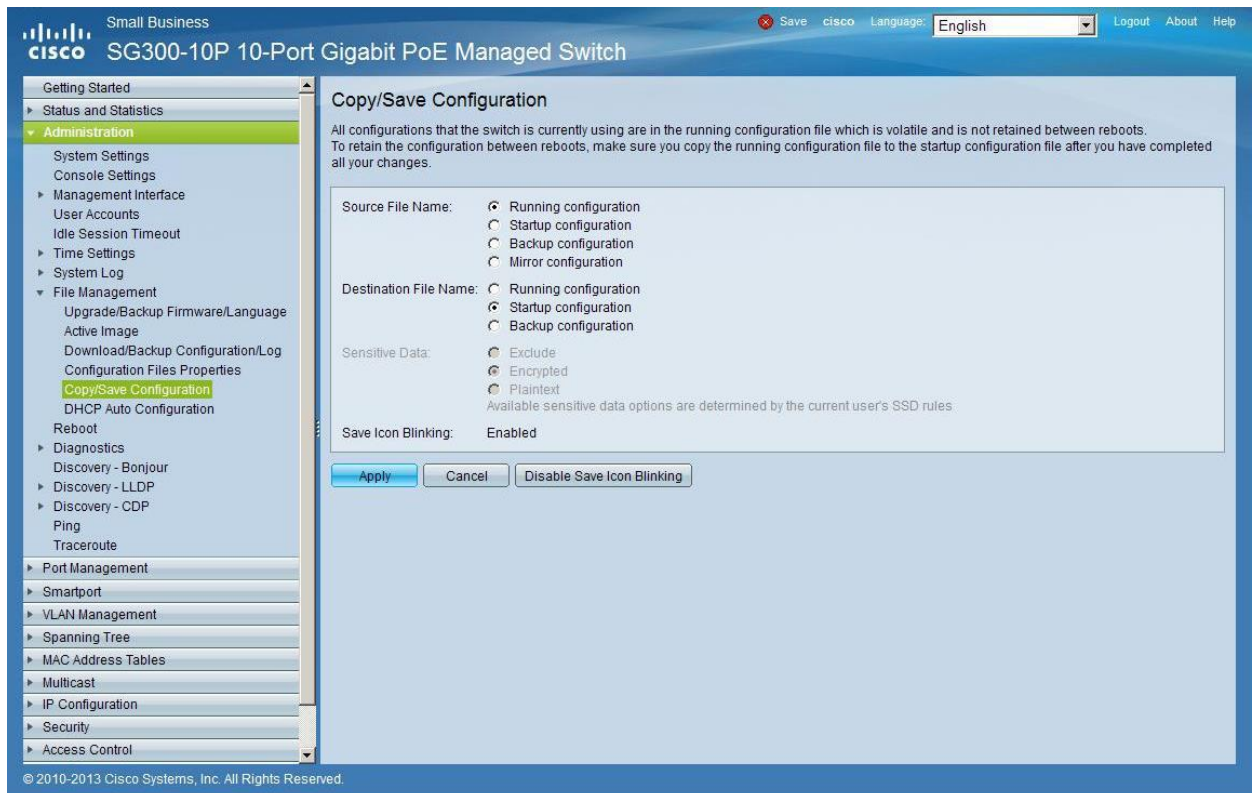

Small Business
cisco SG300-10P 10-Port Gigabit PoE Managed Switch

Save cisco Language: English Logout About Help

Getting Started
Status and Statistics
Administration
System Settings
Console Settings
Management Interface
User Accounts
Idle Session Timeout
Time Settings
System Log
File Management
Upgrade/Backup Firmware/Language
Active Image
Download/Backup Configuration/Log
Configuration Files Properties
Copy/Save Configuration
DHCP Auto Configuration
Reboot
Diagnostics
Discovery - Bonjour
Discovery - LLDP
Discovery - CDP
Ping
Traceroute
Port Management
Smartport
VLAN Management
Spanning Tree
MAC Address Tables
Multicast
IP Configuration
Security
Access Control

Copy/Save Configuration

All configurations that the switch is currently using are in the running configuration file which is volatile and is not retained between reboots. To retain the configuration between reboots, make sure you copy the running configuration file to the startup configuration file after you have completed all your changes.

Source File Name: Running configuration
 Startup configuration
 Backup configuration
 Mirror configuration

Destination File Name: Running configuration
 Startup configuration
 Backup configuration

Sensitive Data: Exclude
 Encrypted
 Plaintext
Available sensitive data options are determined by the current user's SSD rules.

Save Icon Blinking: Enabled

© 2010-2013 Cisco Systems, Inc. All Rights Reserved.

6. Select **Administration** → **File Management** → **Reboot**, and click on the **Reboot** button to reboot the Ethernet switch and make all the changes running.

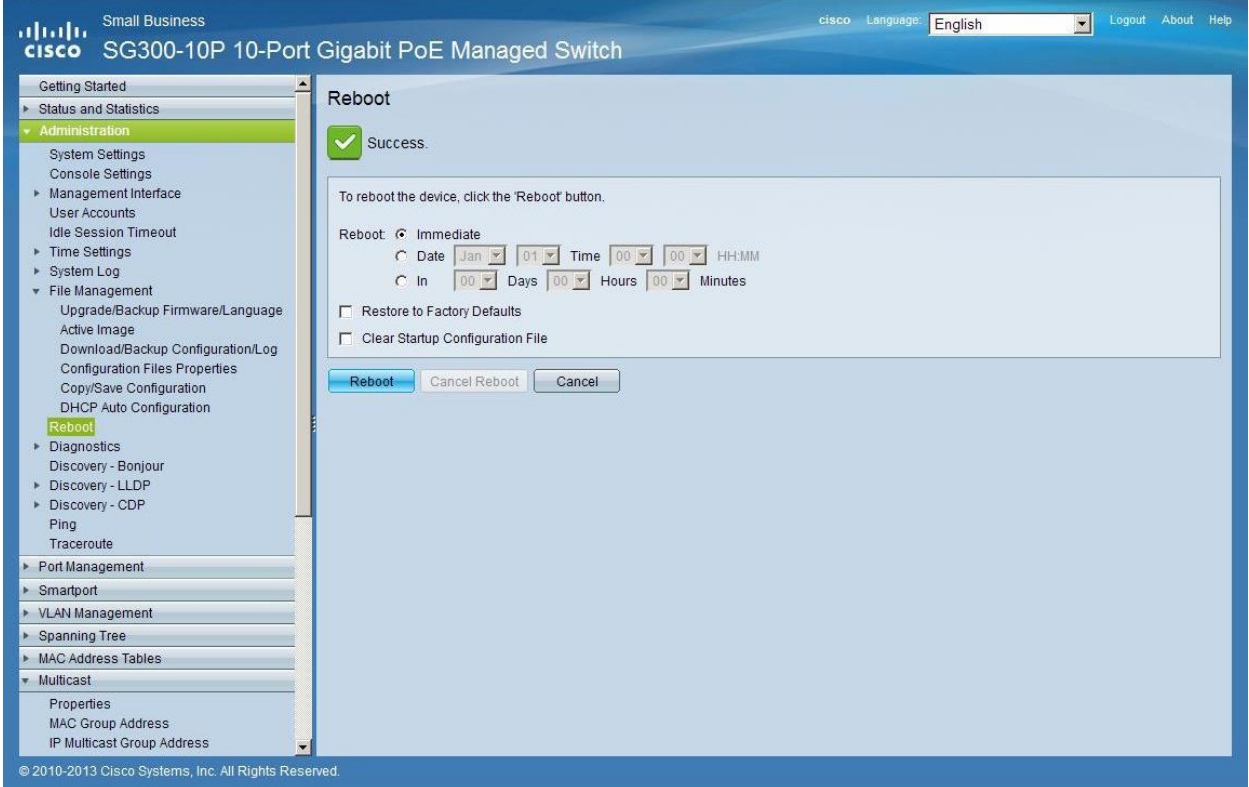

The screenshot shows the Cisco Small Business management interface for an SG300-10P switch. The left sidebar contains a navigation menu with 'Administration' expanded to show 'File Management' and 'Reboot' selected. The main content area is titled 'Reboot' and displays a 'Success' message with a green checkmark. Below the message, there is a section for configuring the reboot: 'Reboot: Immediate', with options for 'Date' (Jan 01) and 'Time' (00:00) in HH:MM format, and 'In' (00) Days (00) Hours (00) Minutes. There are also checkboxes for 'Restore to Factory Defaults' and 'Clear Startup Configuration File'. At the bottom of the configuration area are three buttons: 'Reboot' (highlighted in blue), 'Cancel Reboot', and 'Cancel'. The footer of the page reads '© 2010-2013 Cisco Systems, Inc. All Rights Reserved.'

23 ENABLING JUMBO FRAME

1. Select **Port Management** → **Port Settings**. Enable **Jumbo Frames** by activating the related selection box and click on **Apply**.

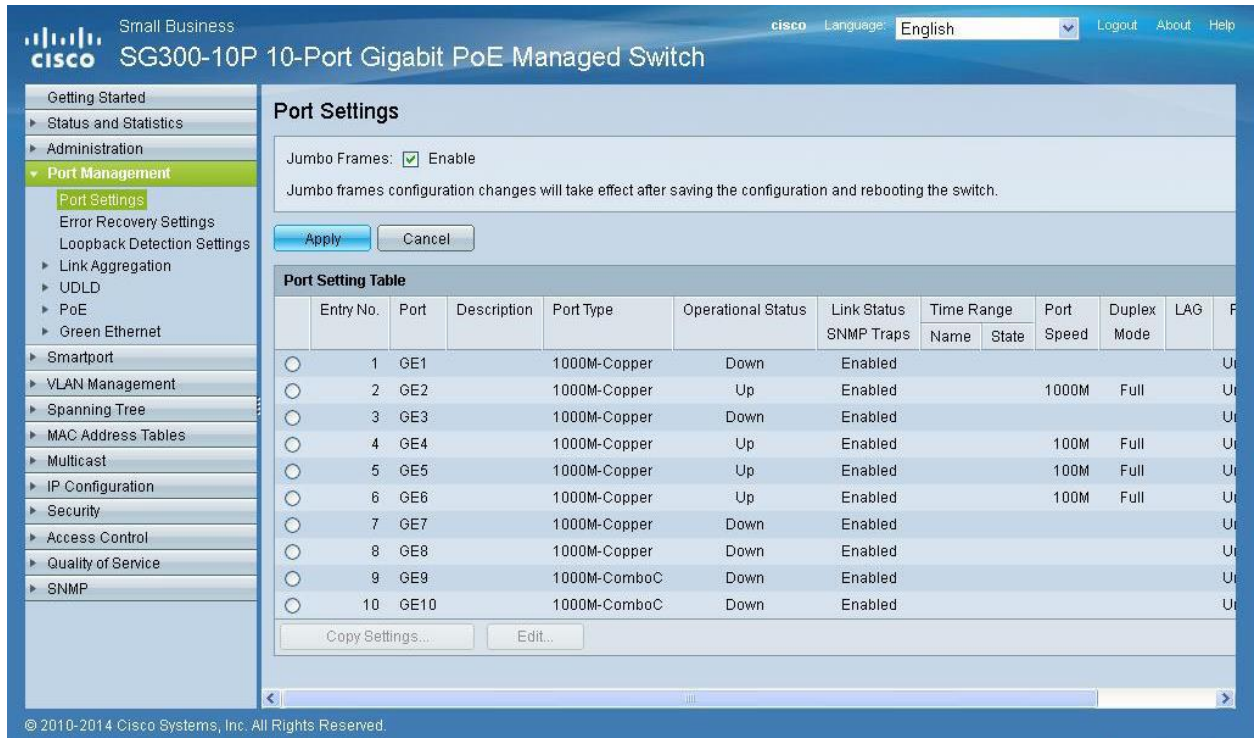

The screenshot shows the Cisco configuration interface for a SG300-10P switch. The 'Port Management' menu is expanded to 'Port Settings'. The 'Jumbo Frames' checkbox is checked and labeled 'Enable'. Below this, a note states: 'Jumbo frames configuration changes will take effect after saving the configuration and rebooting the switch.' There are 'Apply' and 'Cancel' buttons. A 'Port Setting Table' is displayed with the following data:

Entry No.	Port	Description	Port Type	Operational Status	Link Status	Time Range	Port Speed	Duplex Mode	LAG	PoE
<input type="radio"/>	1	GE1	1000M-Copper	Down	Enabled					Un
<input type="radio"/>	2	GE2	1000M-Copper	Up	Enabled		1000M	Full		Un
<input type="radio"/>	3	GE3	1000M-Copper	Down	Enabled					Un
<input type="radio"/>	4	GE4	1000M-Copper	Up	Enabled		100M	Full		Un
<input type="radio"/>	5	GE5	1000M-Copper	Up	Enabled		100M	Full		Un
<input type="radio"/>	6	GE6	1000M-Copper	Up	Enabled		100M	Full		Un
<input type="radio"/>	7	GE7	1000M-Copper	Down	Enabled					Un
<input type="radio"/>	8	GE8	1000M-Copper	Down	Enabled					Un
<input type="radio"/>	9	GE9	1000M-ComboC	Down	Enabled					Un
<input type="radio"/>	10	GE10	1000M-ComboC	Down	Enabled					Un

At the bottom of the table, there are 'Copy Settings...' and 'Edit...' buttons. The footer of the page reads: '© 2010-2014 Cisco Systems, Inc. All Rights Reserved.'

24 CONFIGURING THE DHCP SERVER

The DHCP Server will automatically configure the IP addresses of each device connected to the switch. All the devices need to be set as DHCP client in their own Network Configuration page. This allows avoiding any conflict between devices.

Note: Please check VEO user manual for IP configurations of each product, accordingly to your installation needs.

1. To change the **Ethernet Switch Static IP address** to the same subnet as the AV over IP Devices, select **Administration** → **Management Interface** → **IPv4 Interface**. Set **IP Address Type** to **Static**, and enter the **IP Address** (accordingly to your network requirements), and set the **Network Mask** to 255.255.255.0. In this case we e default IP address. **After applying these settings you need to change the IP address on your computer network interface card to the same subnet just set above.**

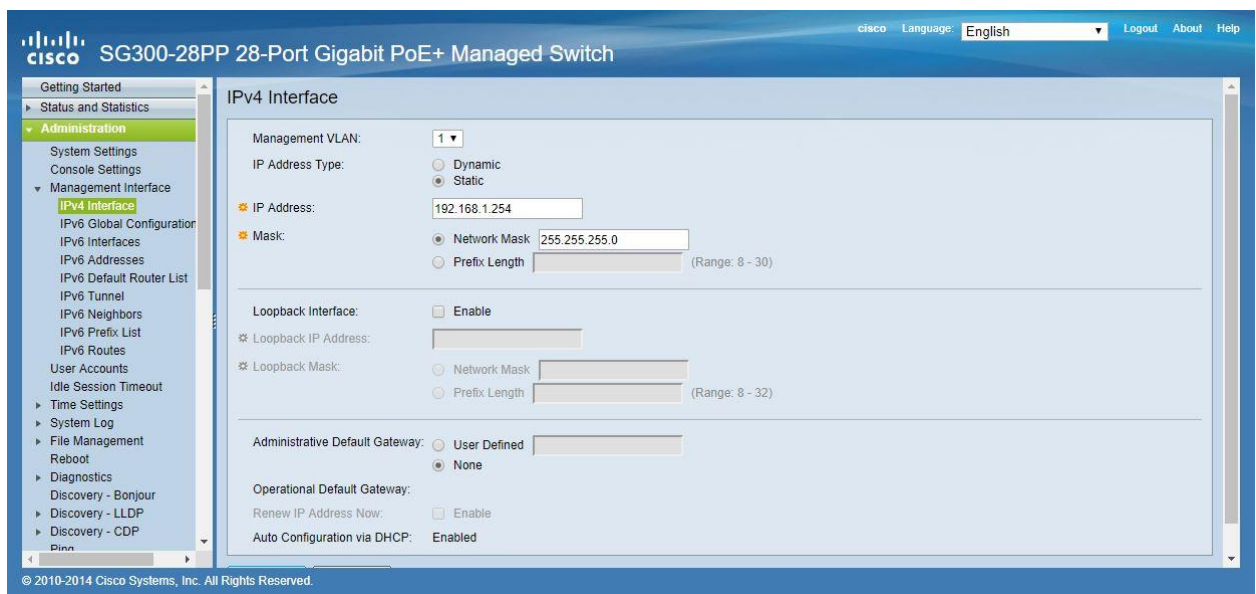

2. Select **IP Configuration** → **DHCP Server** → **Network Pools** and click on the **Add...** button

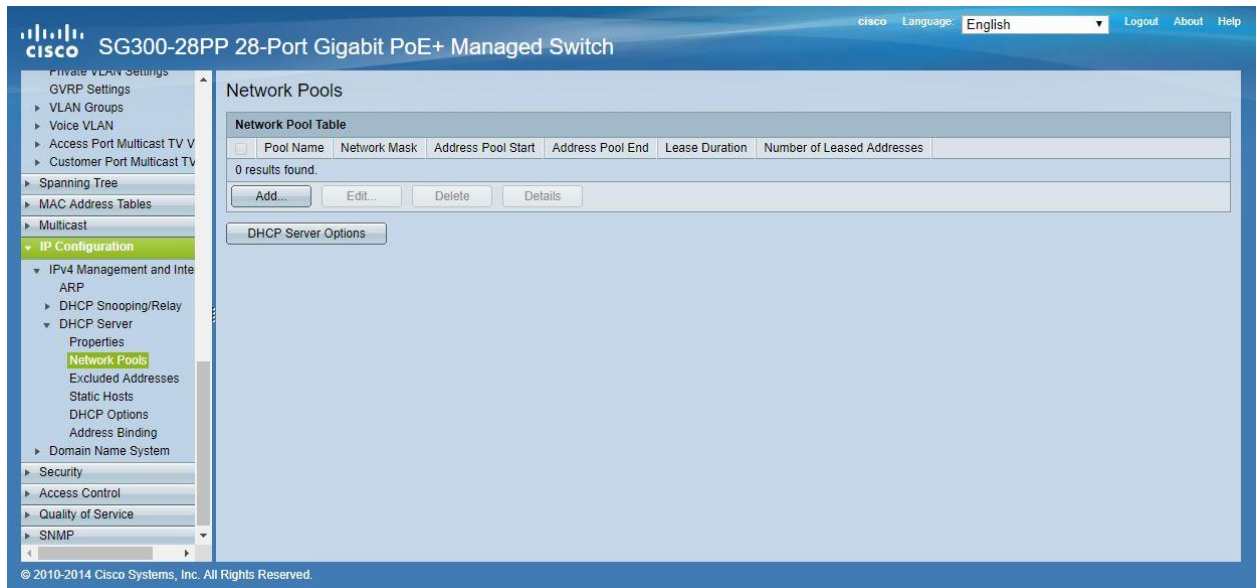

3. Set the **Pool Name**, the **Network Mask** (255.255.255.0), the **Address Pool Start** (192.168.1.10), and the **Address Pool End** (192.168.1.100). Verify that you allocate enough IP addresses for all Transmitters and Receivers present on the network.

Pool Name:

Subnet IP Address:

Mask: Network Mask: Prefix Length: (Range: 8 - 30)

Address Pool Start:

Address Pool End:

Lease Duration: Infinite Days: Hours: Minutes: (Default: 1 Day)

Default Router IP Address (Option 3): Auto Disable User Defined:

Domain Name Server IP Address (Option 6):

Domain Name (Option 15): (0/32 characters used)

NetBIOS WINS Server IP Address (Option 44):

NetBIOS Node Type (Option 46): Hybrid Mixed Peer-to-Peer Broadcast

SNTP Server IP Address (Option 4):

File Server IP Address (saddr):

File Server Host Name (sname/Option 66): (0/64 characters used)

Configuration File Name (file/Option 67): (0/128 characters used)

Click on the **Apply** button.

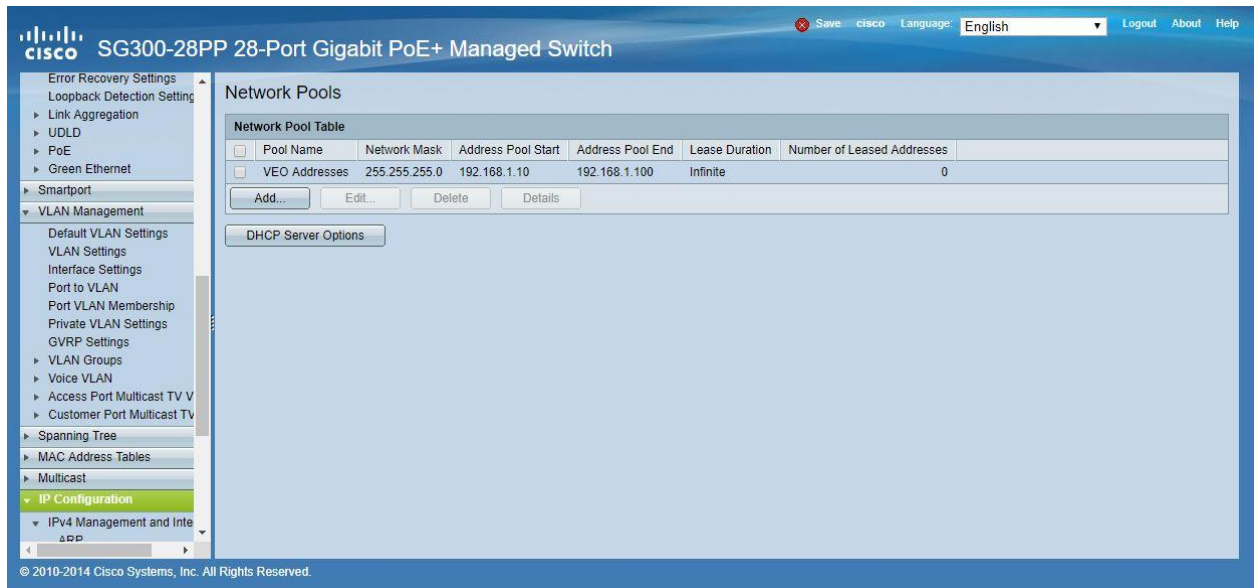

4. Select IP Configuration → IPv4 Management and Interfaces → DHCP Server → Properties.

Enable the **DHCP Server Status** by activating the related selection box and clicking on **Apply**.

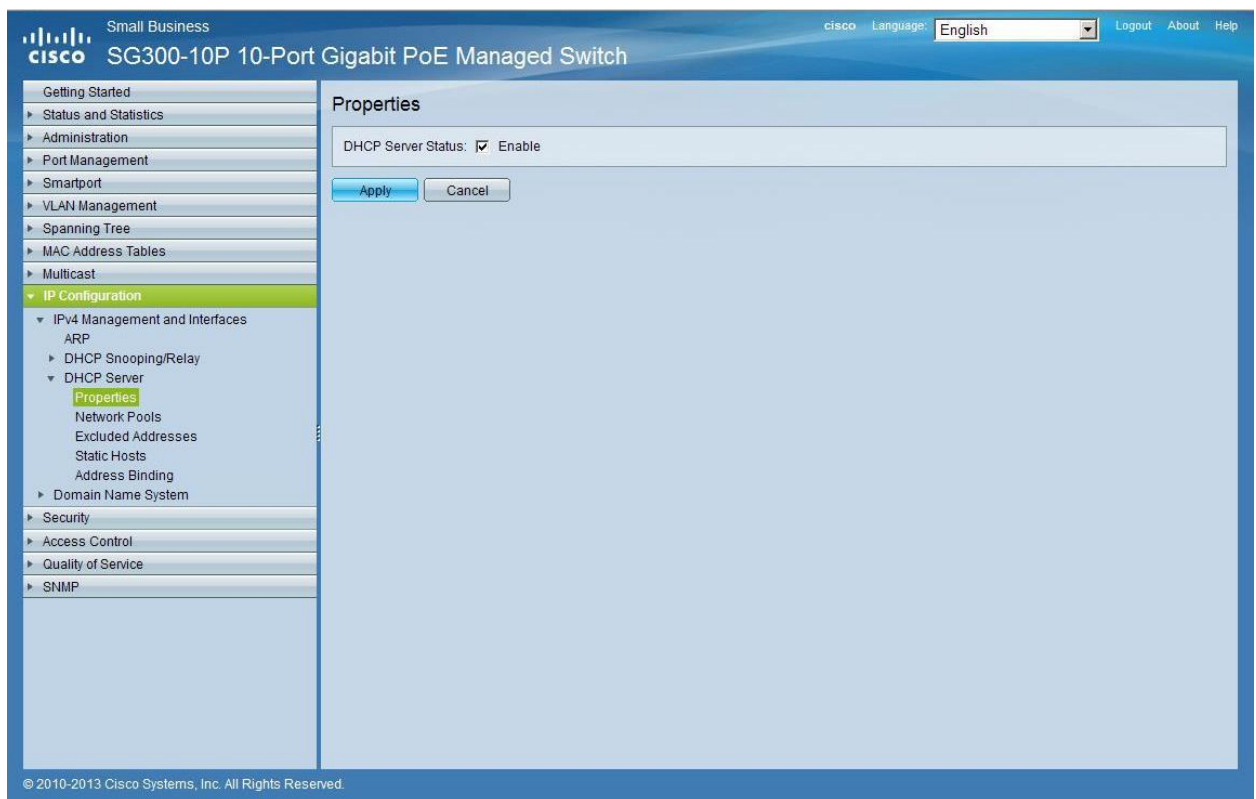

5. Select **Administration** → **File Management** → **Copy/Save Configuration**. Enable **Running Configuration** and **Startup Configuration** as shown below and save all changes by clicking **Apply**.

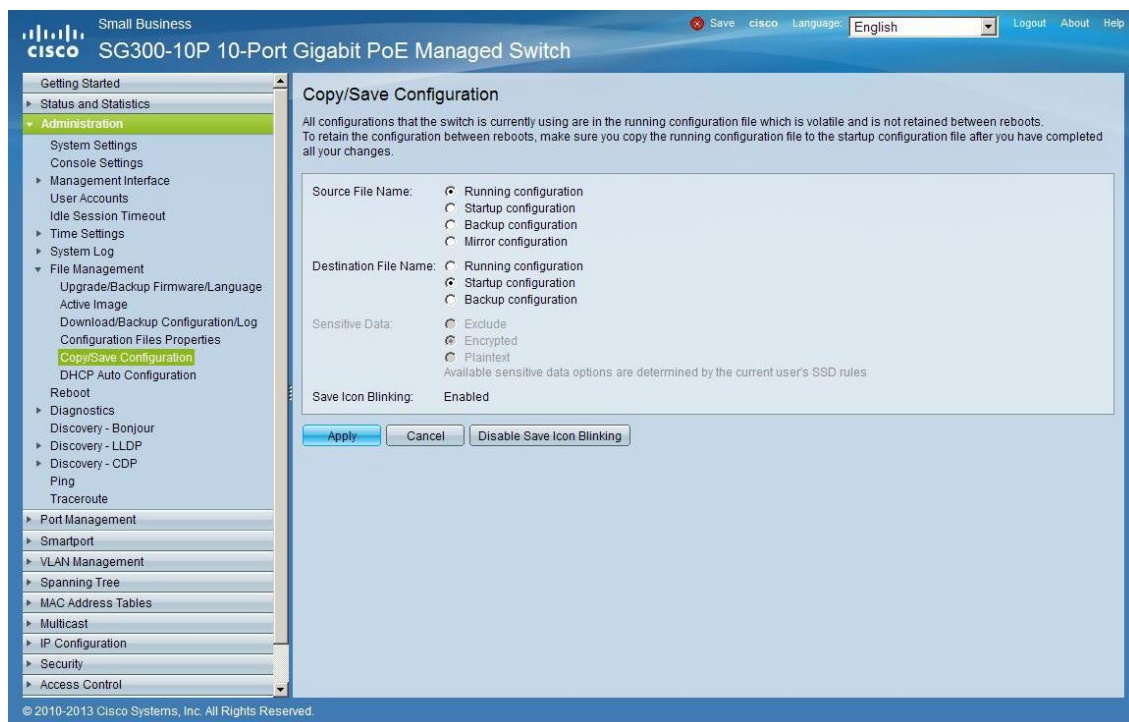

6. Select **Administration** → **File Management** → **Reboot**, and click on the **Reboot** button to reboot the Ethernet switch and make all the changes running.

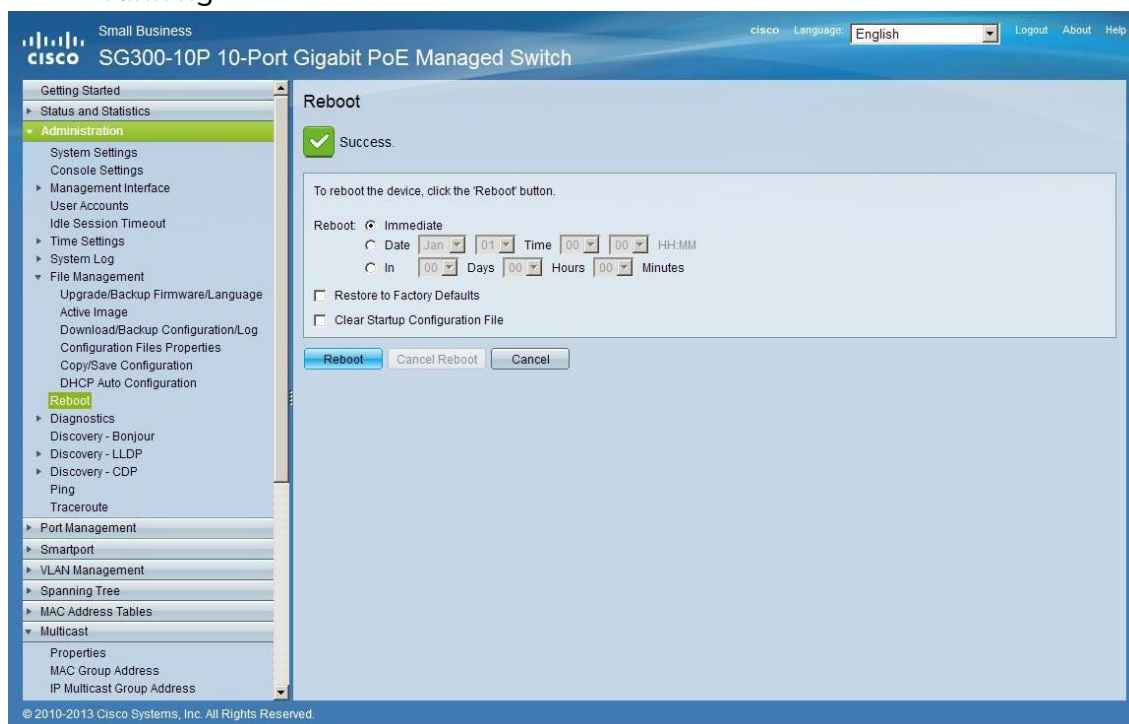

VEO-XTI1C / VEO-XRI1C VEO-XTI2L / VEO-XRI2L

How to configure D-Link DGS-1210 Ethernet Switch for Dante™ Networks and VEO over IP products



QUICK START GUIDE

25 HOW TO CONFIGURE D-LINK DGS-1210 ETHERNET SWITCH INTRODUCTION

Due to the network requirements established by Audinate® for Dante™ Networks and taking in consideration the network requirements for our VEO over IP devices, this quick guide aims to explain how to configure the D-Link DGS-1210 family of switches in order to make them compliant to these requirements. All the requirements are mandatory for every switch used in a Dante or VEO over IP system, independently by the brands.

26 ESTABLISHING COMMUNICATION WITH D-LINK ETHERNET SWITCH

4. Connect your computer to the D-Link Ethernet Switch using an Ethernet cable. D-Link DSG-1210 Ethernet Switches come with a default Static IP address of **10.90.90.90**;
5. Configure your PC with a Static IP address in the same subnet such as 10.90.90.66, with subnet mask 255.0.0.0.
6. Open your Internet browser and type the default IP address of the switch: <http://10.90.90.90>. The default **Password** is “**admin**”.

27 ENABLING IGMP PROTOCOL

Internet Group Management Protocol (IGMP) is mandatory for the correct operation of VEO over IP products when they are configured as multicast devices. Without IGMP enabled, audio/video signal can't be transmitted properly or it may freeze.

With IGMP snooping, the Smart Managed Switch can make intelligent multicast forwarding decisions by examining the content of each frame's Layer 2 MAC header. IGMP snooping can help reduce cluttered traffic on the LAN. With IGMP snooping enabled, the Smart Managed Switch will forward multicast traffic only to connections that have group members attached.

7. Select **L2 Function**→**Multicast**→**IGMP Snooping**
8. Enable **IGMP Snooping** by activating the related selection box and clicking on **Apply**.

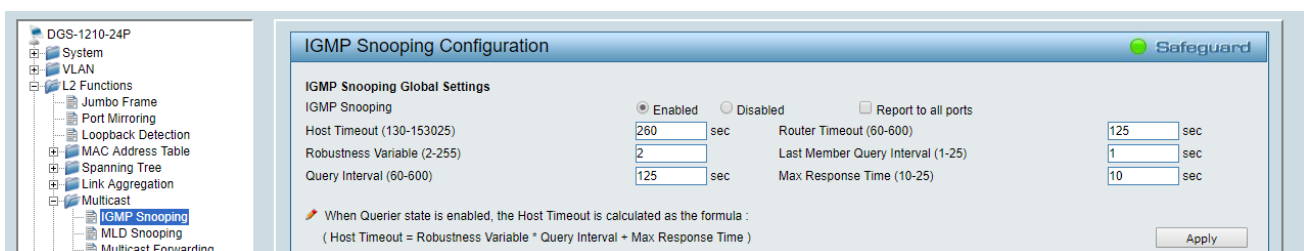

9. Select **Save** in the upper left corner and press **Save Config** button in order to ensure that all changes are saved as current configuration in use.

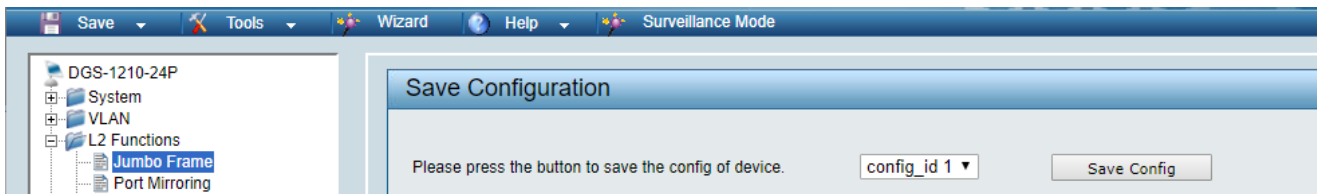

28 ENABLING Jumbo Frame

D-Link Gigabit Smart Managed Switches support jumbo frames (frames larger than the Ethernet frame size of 1536 bytes) of up to 9216 bytes (tagged). It is disabled by default.

2. Select **L2 Function**→ **Jumbo Frame**

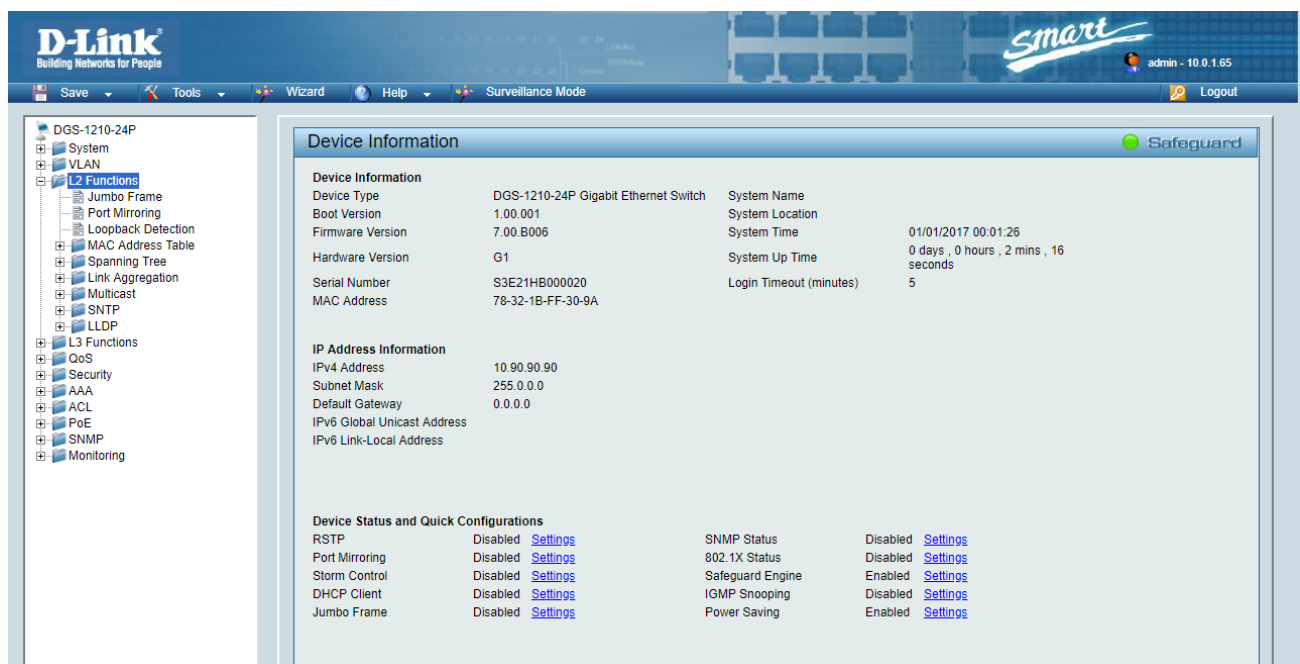

3. Enable **Jumbo Frame** by activating the related selection box and click on **Apply**.

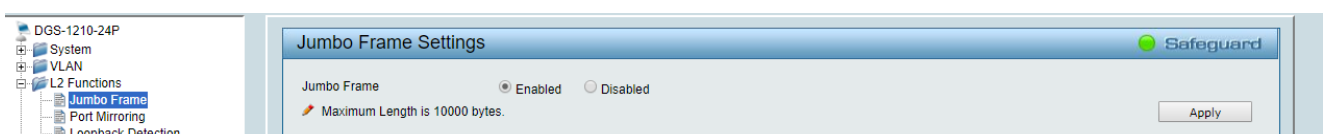

4. Select **Save** in the upper left corner and press **Save Config** button in order to ensure that all changes are saved as current configuration in use.

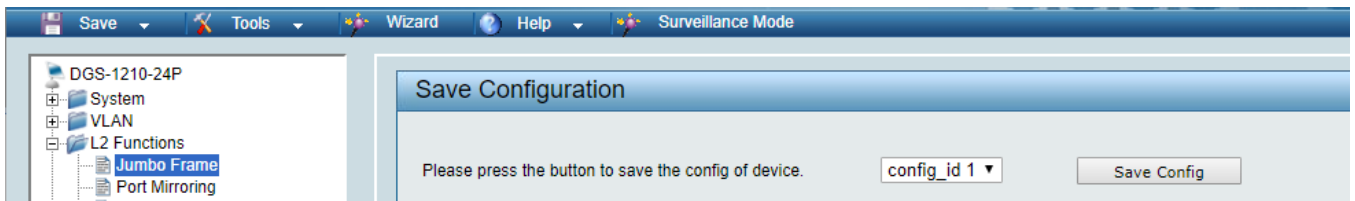

29 Disabling POWER Saving and EEE (Energy Efficient Ethernet)

In order to prevent audio or video drops out, all the power saving features need to be disabled. This is a mandatory requirement for Dante™ Networks.

1. Select **System** → **Power Saving**
2. On **Global Settings** disable Cable Length Detection/Link Status Detection and press **Apply**

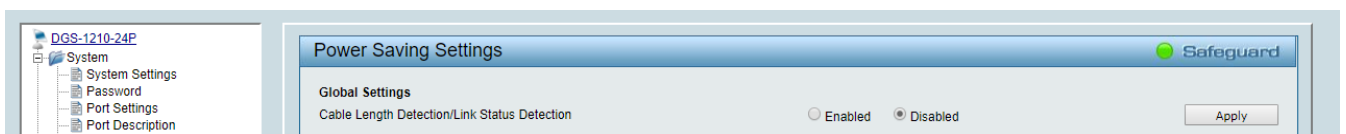

3. Select **IEEE802.3az EEE settings** and ensure that the feature is disabled on the ports where Dante or VEO devices are connected

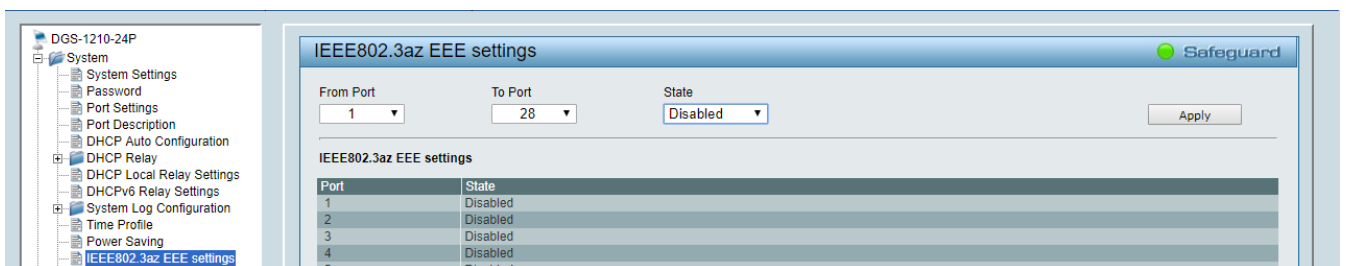

4. Select **Save** in the upper left corner and press **Save Config** button in order to ensure that all changes are saved as current configuration in use.

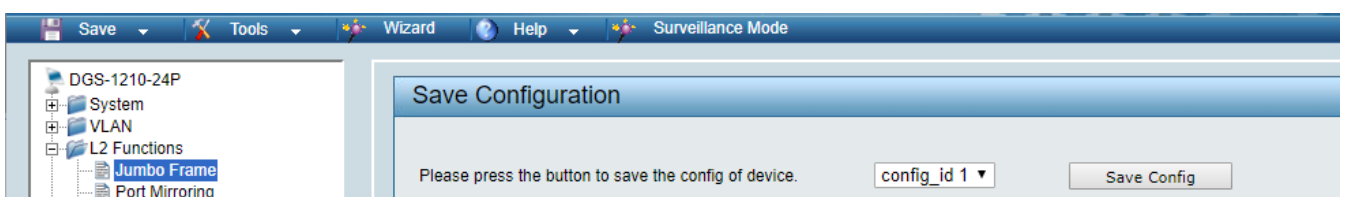

30 CREATING VLANs FOR DANTE™, VIDEO OVER IP AND CONTROL COEXISTENCE

In AV system where Dante™ and Video over IP traffic are sharing the same network switch, VLANs are highly recommended because Video over IP could interfere with Dante™ in the same network.

A VLAN allows isolating the network traffic of a predefined group of ports; in case of Audio and Video systems we need to create two VLANs: one for Audio and one for Video. In this case, a device connected to the Audio VLAN can't communicate with a device connected to the Video VLAN.

When a control device (like a touch panel) is required, it needs to communicate both with Audio and Video devices; in this case we need to use a particular feature called Asymmetric VLAN that allows sharing traffic between different VLANs only on predefined ports.

In the following example (Fig. 1) we have:

- **MIMO4040DN** matrix with Dante™ (Control on **port 1**; Dante on **port 2**)
- **WPNETTOUCH** (Control on **port 3**)
- **DN404BOB** (Dante/Control on **port 5**)
- **VEO-XTI2L** (Video/Control on **port 15**)
- **VEO-XRI2L** (Video/Control on **port 16**)
- **VEO-XRI2L** (Video/Control on **port 17**)

We need to create 2 VLANs like follows:

- 1 Audio/Control VLAN (default):
- 2 Video/Control VLAN:

- Ports 1-14
- Ports 15-28

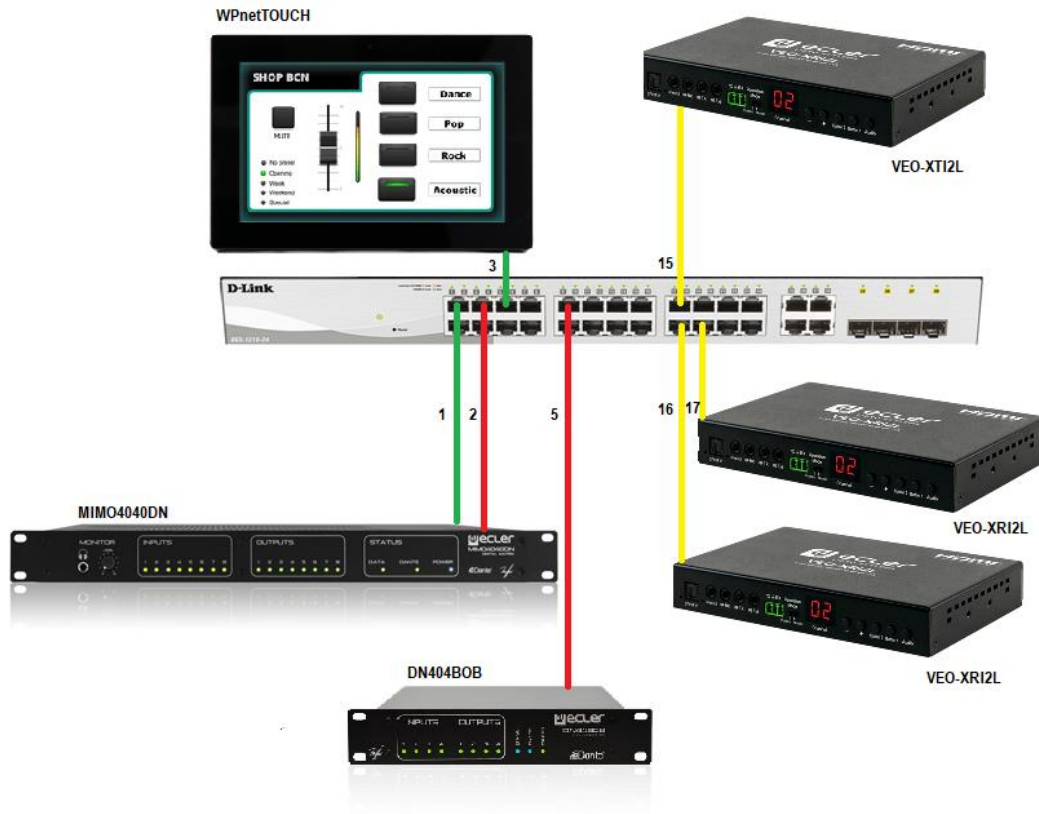
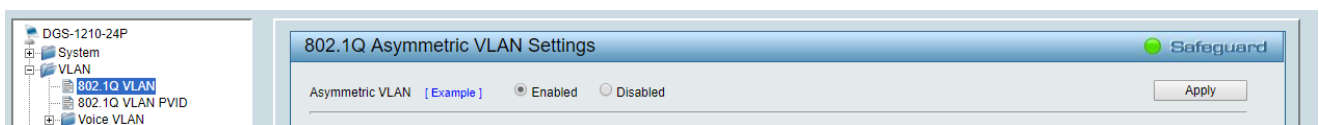
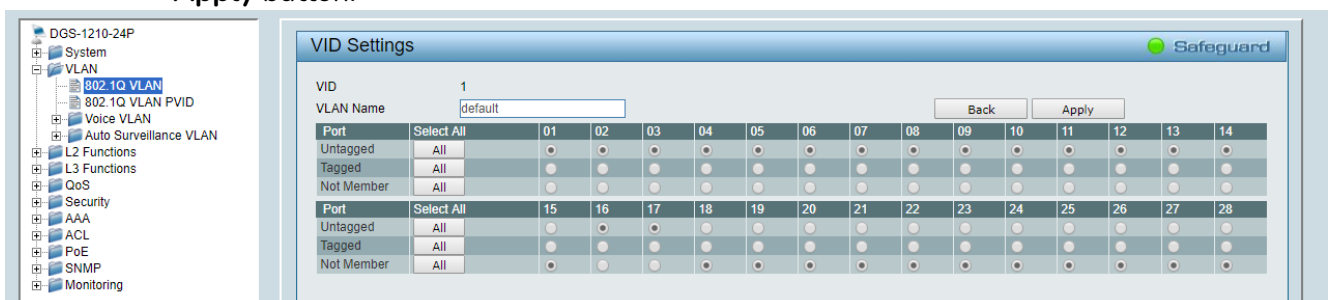

Fig. 1

- 5. Select VLAN→802.1Q VLAN, enable Asymmetric VLAN and click on Apply



- 6. Click on 1 and mark as Untagged all the Audio/Control VLAN ports (1-14), adding the Video/Control VLAN ports that need to share Control (16-17). Click on the Apply button.



7. Create a second VLAN for Video/Control by clicking on **Add** button

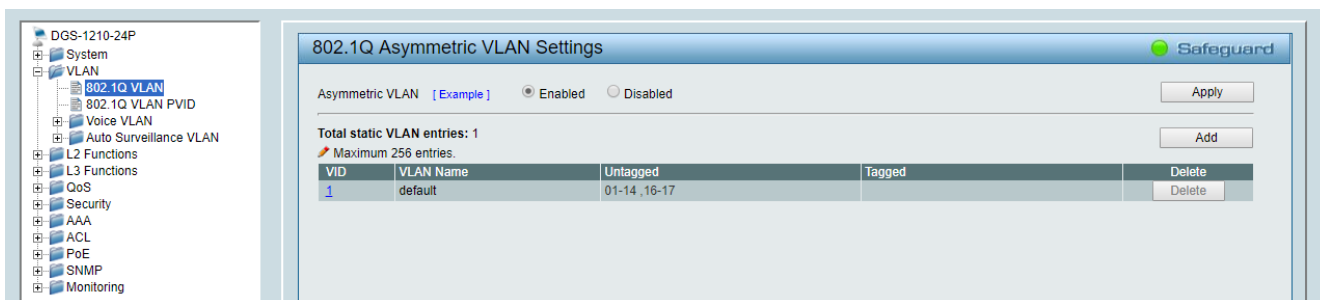

8. Assign 2 as VID, and Video as Name to the new VLAN; mark as Untagged all the Video/Control VLAN ports (15-28), adding the Audio/Control VLAN ports that need to share Control traffic (1-3). Click on the **Apply** button.

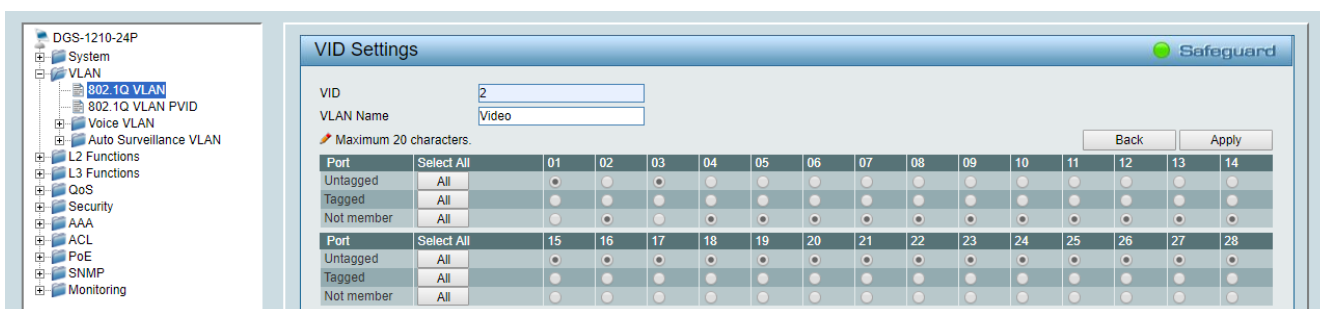

9. Select **Save** in the upper left corner and press **Save Config** button in order to ensure that all changes are saved as current configuration in use.

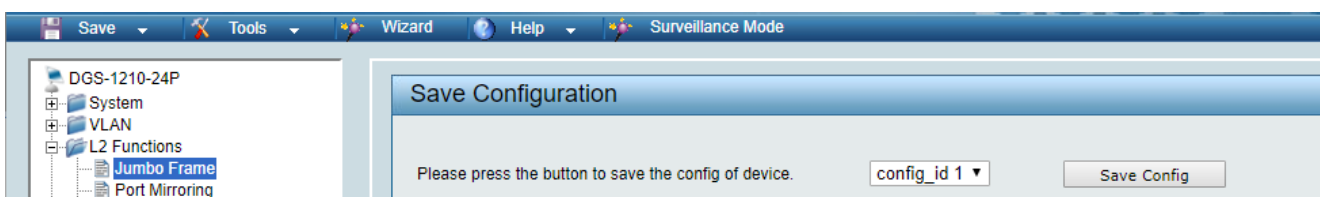

All product characteristics are subject to variation due to production tolerances. **NEEC AUDIO BARCELONA S.L.** reserves the right to make changes or improvements in the design or manufacturing that may affect these product specifications

For technical queries contact your supplier, distributor or complete the contact form on our website, in [Support / Technical requests](#).

Motors, 166-168 08038 Barcelona - Spain - (+34) 932238403 | information@ecler.com | www.ecler.com